

TS SEALED SERIES

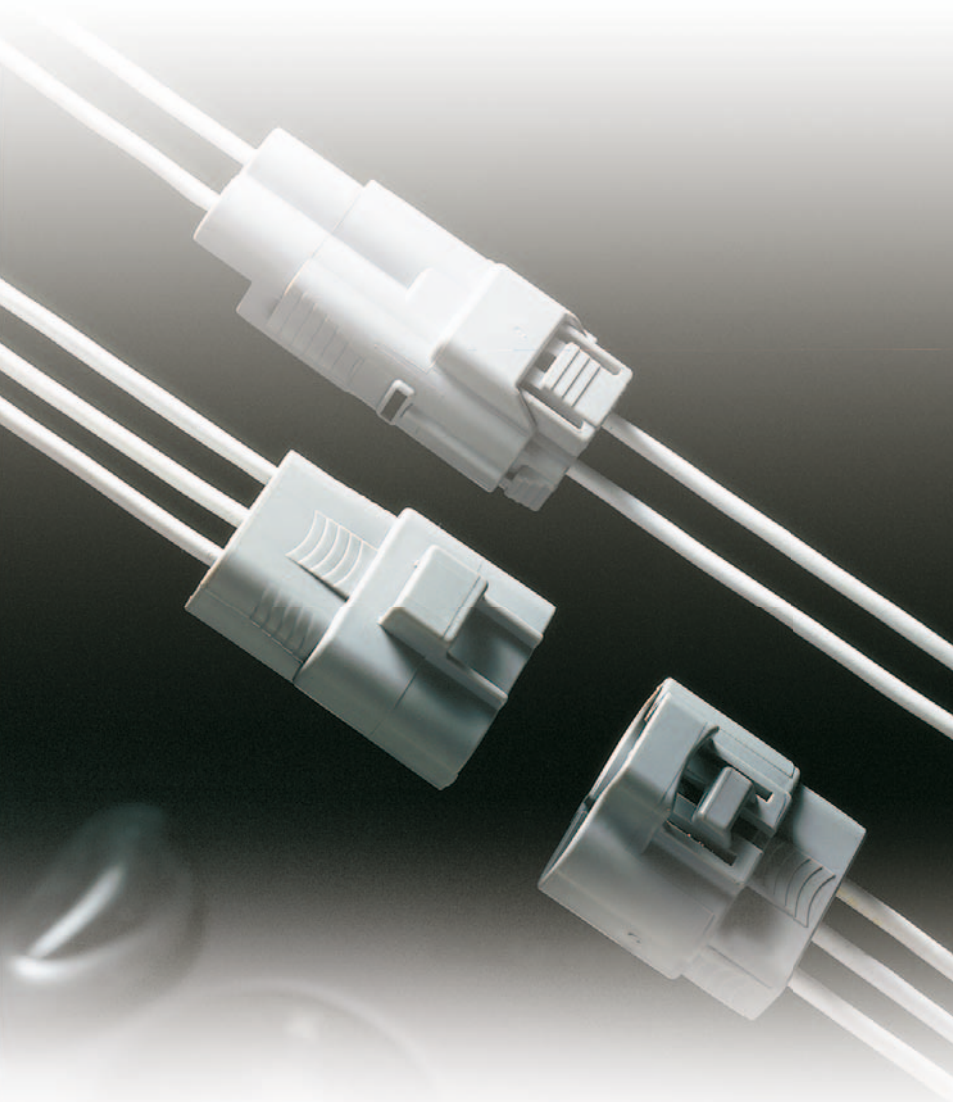

Features

The TS sealed connector series has a mechanism of terminal position assurance. This series consists of 0.64mm, 2.3mm, 4.8mm and 8.0mm types classified according to terminal size, covering an extensive array of applications from signal to power circuits.

- Retainers are pre-mounted on the connector housing, and are structured to enable setting by the same simple operation regardless of the number of ways, improving operability.
- These connectors can be directly secured to a bracket on the car body.
- RoHS/ELV Compliant

特長

TS防水シリーズは、挿入不足のターミナルを検知する機構を備えたコネクタシリーズです。ターミナルサイズにより0.64mm・2.3mm・4.8mm・8.0mmで構成されており、信号回路からパワー回路まで幅広くご利用いただけます。

- リテーナは、コネクタハウジングに予め組み付けられており、また極数に関係なく簡単な同一作業でセットすることができる構造になっているので、作業性が向上します。
- コネクタは、ボデー側のブラケットに直接固定することができます。
- RoHS/ELV対応

TS SEALED SERIES for STANDARD

0.64mm (025)

Structure / 構造

B-02

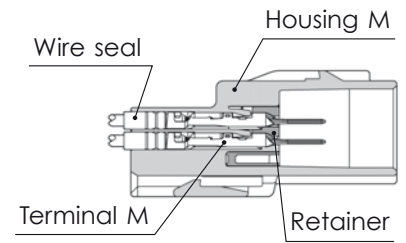
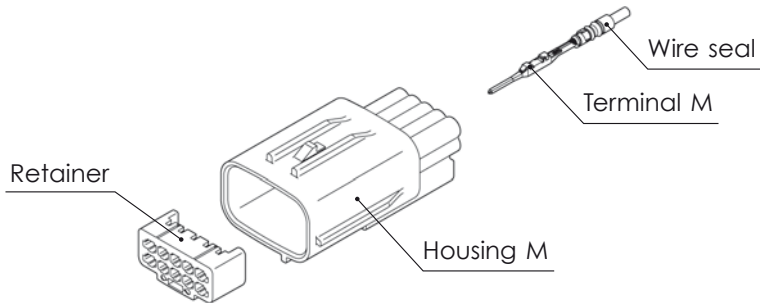

Connector M

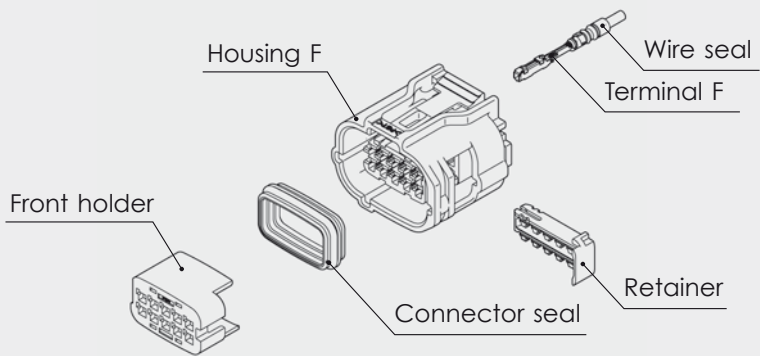

Connector F

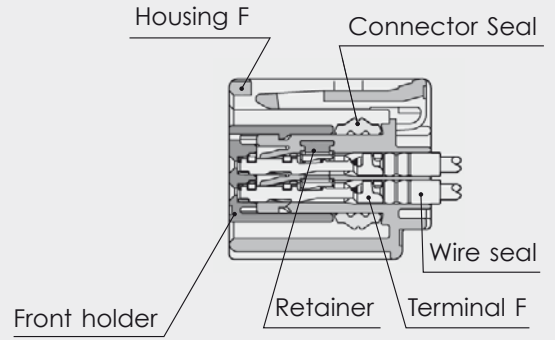

0.64mm (025)

Terminal (UNIT : mm)

(S)

F (8240-0336)

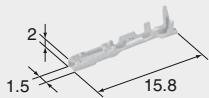

Cable size (mm ²) 適用電線サイズ	0.13
Material 材質	Heat-resistant copper alloy
Surface treatment 表面処理	Tin-plated Snメッキ

(S)

Au

F (8240-0337)

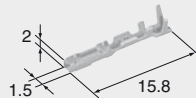

Cable size (mm ²) 適用電線サイズ	0.13
Material 材質	Heat-resistant copper alloy
Surface treatment 表面処理	Gold-plated Auメッキ

(M)

Cable size (mm ²) 適用電線サイズ	0.22~0.5
Material 材質	Brass 黄銅
Surface treatment 表面処理	Tin-plated Snメッキ

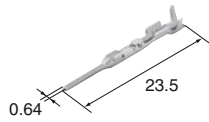

(M)

Au

Cable size (mm ²) 適用電線サイズ	0.22~0.5
Material 材質	Brass 黄銅
Surface treatment 表面処理	Gold-plated Auメッキ

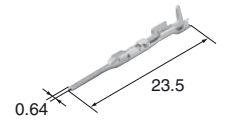

M (8100-3617)

F (8100-3455)

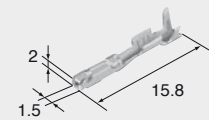

Cable size (mm ²) 適用電線サイズ	0.22~0.35
Material 材質	Heat-resistant copper alloy
Surface treatment 表面処理	Tin-plated Snメッキ

M (8100-3708)

F (8100-3456)

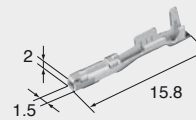

Cable size (mm ²) 適用電線サイズ	0.22~0.35
Material 材質	Heat-resistant copper alloy
Surface treatment 表面処理	Gold-plated Auメッキ

(L)

F (8240-0287)

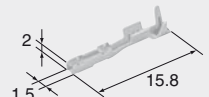

Cable size (mm ²) 適用電線サイズ	0.5
Material 材質	Heat-resistant copper alloy
Surface treatment 表面処理	Tin-plated Snメッキ

(L)

Au

F (8240-0288)

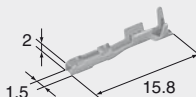

Cable size (mm ²) 適用電線サイズ	0.5
Material 材質	Heat-resistant copper alloy
Surface treatment 表面処理	Gold-plated Auメッキ

0.64mm (025)

B-04

Wire seals (UNIT : mm)

- The wire seals are common to M and F.
*A wireseal depends on a chosen cable.
- ワイヤシールは M、F 共用です。
※使用電線により使用ワイヤシールが異なります。

(SS)

(7165-1043)

Cable size (mm ²) 適用電線サイズ	(CHFUS/0.22)
Cable overall diameter (mm) 電線仕上り外径	0.95~1.05
Material 材質	Silicon シリコン
Color 色相	Green 緑

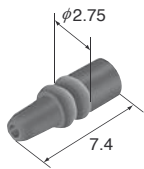

(M)

(7165-1198)

Cable size (mm ²) 適用電線サイズ	(AVSS/0.3) (AVSSH/0.3) (AESSX/0.3)
Cable overall diameter (mm) 電線仕上り外径	1.4~1.5
Material 材質	Silicon シリコン
Color 色相	Dark Yellow 濃黄

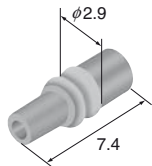

0.64mm (025)

Dummy plugs (UNIT : mm)

- Dummy plugs are common to M and F.
- Dummy plugs are used to blind unused terminal holes.
- ダミー栓は M、F 共用です。
- 不必要なターミナル穴を塞ぐために、ダミー栓を使用します。

(3S)

(7165-1423)

Cable size (mm ²) 適用電線サイズ	(CHFUS/0.13)
Cable overall diameter (mm) 電線仕上り外径	0.85~0.95
Material 材質	Silicon シリコン
Color 色相	Light Brown 淡茶

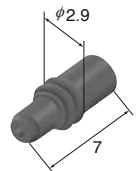

(S)

(7165-1312)

Cable size (mm ²) 適用電線サイズ	(CHFUS/0.35~0.5)
Cable overall diameter (mm) 電線仕上り外径	1.1~1.4
Material 材質	Silicon シリコン
Color 色相	Violet 紫

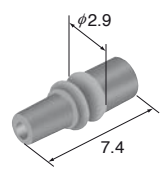

(L)

(7165-1199)

Cable size (mm ²) 適用電線サイズ	(AVSS/0.5) (AVSSH/0.5) (AVSSX/0.5) (AESSX/0.5)
Cable overall diameter (mm) 電線仕上り外径	1.6~1.7
Material 材質	Silicon シリコン
Color 色相	Red Violet 赤紫

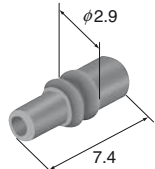

(7165-0797)

Material 材質	NBR
Color 色相	Light Gray 淡灰

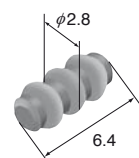

0.64mm (025)

Housing (UNIT : mm)

Ref: Terminal part No. B-03
ターミナル参照頁

Ref: wire seal No. B-04
ワイヤシール参照頁

Ref: Dummy plug No. B-04
ダミー栓参照頁

Material PBT
材質

2way

Color Black
色相 黒

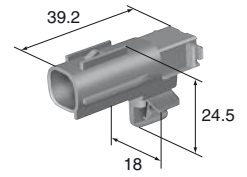

M (6188-4797)

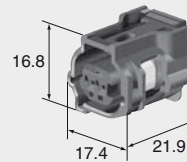

F (6189-1161)

Color Black
色相 黒

2way

F (6189-7020)

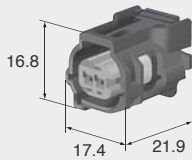

Color Black
色相 黒

3way

Color Black
色相 黒

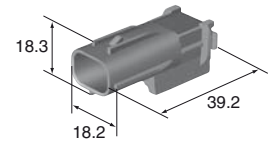

M (6188-4920)

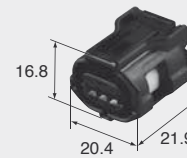

F (6189-1129)

Color Black
色相 黒

2way

F (6189-7073)

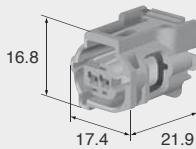

Color Gray
色相 灰

4way

F (6189-1231)

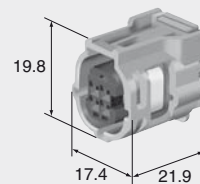

Color Gray
色相 灰

5way

F (6189-1046)

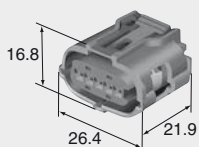

Color Black
色相 黒

6way

Color 色相 Natural 自然色

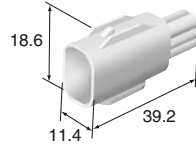

M (6188-0706)

F (6189-1142)

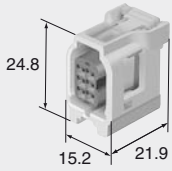

Color 色相 Natural 自然色

6way

F (6189-1083)

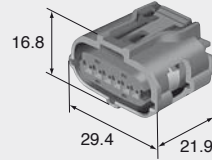

Color 色相 Black 黒

6way

F (6189-7100)

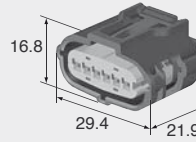

Color 色相 Black 黒

8way

Color 色相 Gray 灰

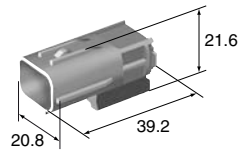

M (6188-0779)

F (6189-1240)

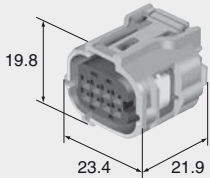

Color 色相 Gray 灰

10way

Color 色相 Black 黒

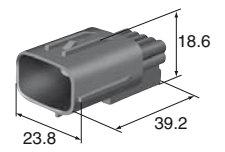

M (6188-0696)

F (6189-1134)

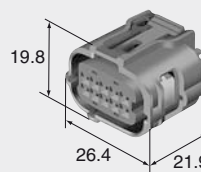

Color 色相 Black 黒

12way

F (6189-1128)

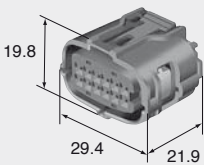

Color 色相 Black 黒

13way

Color 色相 Gray 灰

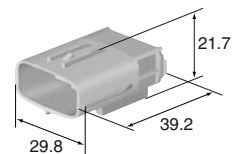

12way

F (6189-1133)

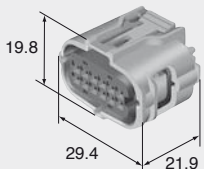

Color 色相 Gray 灰

M (6188-4914)

F (6189-1092)

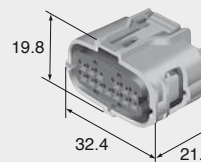

Color 色相 Gray 灰

15way

F (6189-1135)

Color
色相 Gray
 灰

17way

F (6189-7110)

Color
色相 Gray
 灰

20way

F (6189-7167)

Color
色相 Black
 黒

30way

F (6189-6987)

Color
色相 Gray
 灰

TS SEALED SERIES for STANDARD

2.3mm (090)

Structure / 構造

B-08

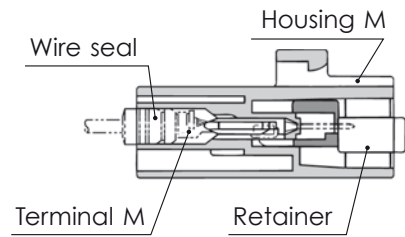
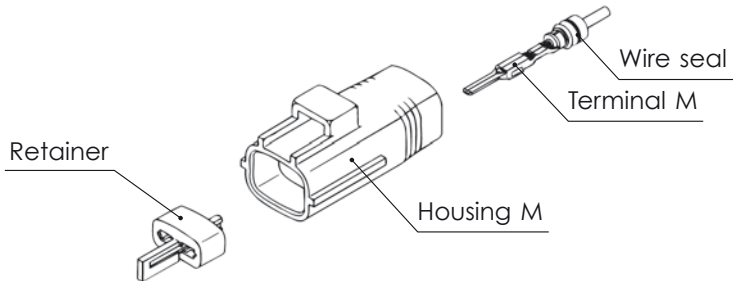

Connector M

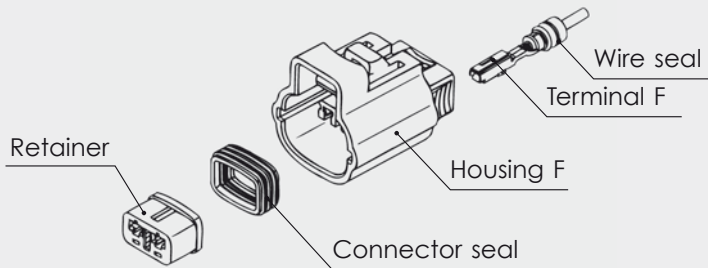

Connector F

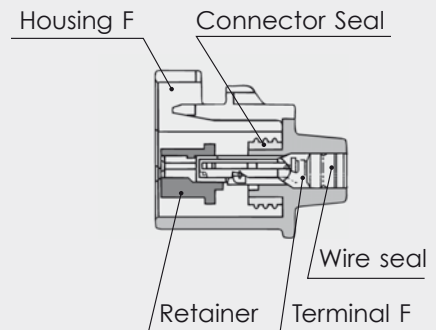

2.3mm (090)

Terminal (UNIT : mm)

(S)

Cable size (mm ²) 適用電線サイズ	0.3~0.5
Material 材質	Brass 黄銅
Surface treatment 表面処理	Tin-plated Snメッキ

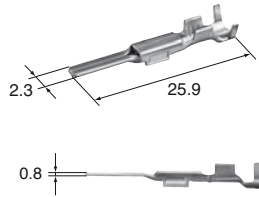
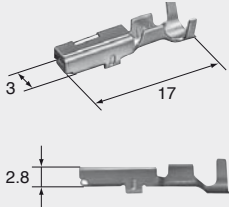
**M (8100-0457)**

Cable size (mm ²) 適用電線サイズ	0.3~0.5
Material 材質	Heat-resistant copper alloy
Surface treatment 表面処理	Tin-plated Snメッキ

F (8100-0460)**(S)**

Cable size (mm ²) 適用電線サイズ	0.3~0.5
Material 材質	Brass 黄銅
Surface treatment 表面処理	Gold-plated Auメッキ

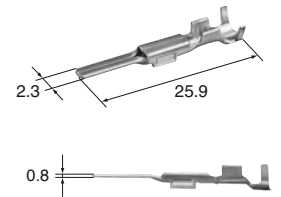
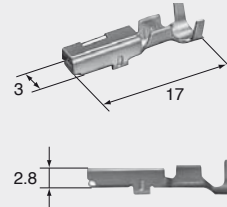
**M (8100-1340)**

Cable size (mm ²) 適用電線サイズ	0.3~0.5
Material 材質	Heat-resistant copper alloy
Surface treatment 表面処理	Gold-plated Auメッキ

F (8100-1344)**(M)**

Cable size (mm ²) 適用電線サイズ	0.5~1.25
Material 材質	Brass 黄銅
Surface treatment 表面処理	Tin-plated Snメッキ

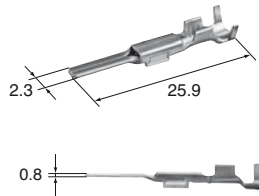
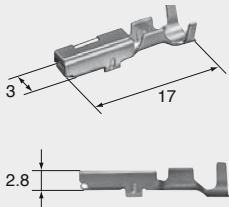
**M (8100-0458)**

Cable size (mm ²) 適用電線サイズ	0.5~1.25
Material 材質	Heat-resistant copper alloy
Surface treatment 表面処理	Tin-plated Snメッキ

F (8100-0461)**(M)**

Cable size (mm ²) 適用電線サイズ	0.5~1.25
Material 材質	Brass 黄銅
Surface treatment 表面処理	Gold-plated Auメッキ

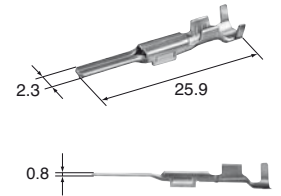
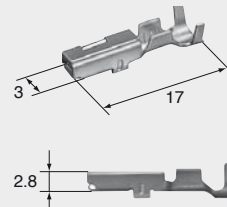
**M (8100-1007)**

Cable size (mm ²) 適用電線サイズ	0.5~1.25
Material 材質	Heat-resistant copper alloy
Surface treatment 表面処理	Gold-plated Auメッキ

F (8100-0594)**(L)**

Cable size (mm ²) 適用電線サイズ	2.0
Material 材質	Brass 黄銅
Surface treatment 表面処理	Tin-plated Snメッキ

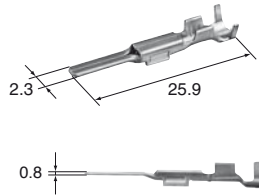
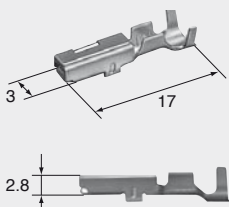
**M (8100-0459)**

Cable size (mm ²) 適用電線サイズ	2.0
Material 材質	Heat-resistant copper alloy
Surface treatment 表面処理	Tin-plated Snメッキ

F (8100-0462)**(L)**

Cable size (mm ²) 適用電線サイズ	2.0
Material 材質	Brass 黄銅
Surface treatment 表面処理	Gold-plated Auメッキ

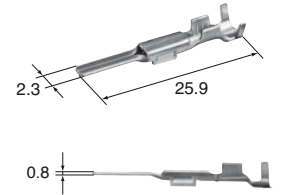
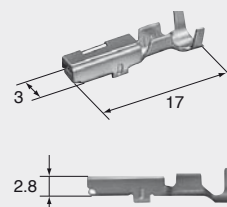
**M (8100-1008)**

Cable size (mm ²) 適用電線サイズ	2.0
Material 材質	Heat-resistant copper alloy
Surface treatment 表面処理	Gold-plated Auメッキ

F (8100-0817)

B-09

TS SEALED SERIES

2.3mm (090)

Wire seals (UNIT : mm)

The wire seals are common to M and F.

- P5 : For 5mm pitch housing/Please inquire us for the details.
- P6 : For 6mm pitch housing

ワイヤシールはM、F共用です。

- P5 : 5ミリピッチ用／別途お問い合わせください。
- P6 : 6ミリピッチ用

(SS)

(P6)

(7165-0842)

Cable size (mm ²) 適用電線サイズ	(CHFUS/0.35~0.5)
Cable overall diameter (mm) 電線仕上り外径	1.1~1.4
Material 材質	Silicon シリコン
Color 色相	Blue 青

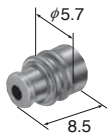

(S)

(P6)

(7165-0349)

Cable size (mm ²) 適用電線サイズ	(AVX·AEX/0.3) (AVS/0.3) (AVSS/0.3~0.85) (AVSSX·AESSX/0.3~0.75) (CAVUS/0.85~1.25)
Cable overall diameter (mm) 電線仕上り外径	1.4~2.0
Material 材質	Silicon シリコン
Color 色相	Dark Brown 濃茶

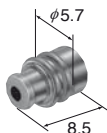

(S)

(P5)

(7165-0342)

Cable size (mm ²) 適用電線サイズ	(AVX·AEX/0.3) (AVS/0.3) (AVSS/0.3~0.85) (AVSSX·AESSX/0.3~0.75) (CAVUS/0.85~1.25)
Cable overall diameter (mm) 電線仕上り外径	1.4~2.0
Material 材質	Silicon シリコン
Color 色相	Brown 茶

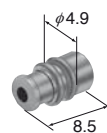

(M)

(P6)

(7165-0395)

Cable size (mm ²) 適用電線サイズ	(AV/0.5) (AVX·AEX/0.5~0.75) (AVS/0.5~0.85) (AVSS/1.25) (AVSSX·AESSX/1.25)
Cable overall diameter (mm) 電線仕上り外径	2.0~2.5
Material 材質	Silicon シリコン
Color 色相	Dark Green 濃緑

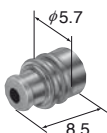

(M)

(P5)

(7165-0343)

Cable size (mm ²) 適用電線サイズ	(AV/0.5) (AVX·AEX/0.5~0.75) (AVS/0.5~0.85) (AVSS/1.25) (AVSSX·AESSX/1.25)
Cable overall diameter (mm) 電線仕上り外径	2.0~2.5
Material 材質	Silicon シリコン
Color 色相	Black 黒

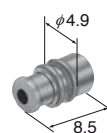

(L)

(P6)

(7165-0351)

Cable size (mm ²) 適用電線サイズ	(AV/1.25) (AVX·AEX/1.25) (AVS/1.25) (AVSS/2.0) (AVSSX·AESSX/2.0)
Cable overall diameter (mm) 電線仕上り外径	2.5~2.9
Material 材質	Silicon シリコン
Color 色相	Dark Gray 濃灰

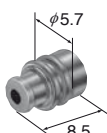

(L)

(P5)

(7165-0344)

Cable size (mm ²) 適用電線サイズ	(AV/1.25) (AVX·AEX/1.25) (AVS/1.25) (AVSS/2.0) (AVSSX·AESSX/2.0)
Cable overall diameter (mm) 電線仕上り外径	2.5~2.9
Material 材質	Silicon シリコン
Color 色相	Dark Blue 紺



2.3mm (090)

Dummy plugs (UNIT : mm)

- Dummy plugs are common to M and F.
- Dummy plugs are used to blind unused terminal holes.
- P5 : For 5mm pitch housing/Please inquire us for the details.
- P6 : For 6mm pitch housing
- ダミー栓はM、F 共用です。
- 不必要なターミナル穴を塞ぐために、ダミー栓を使用します。
- P5 : 5ミリピッチ用／別途お問い合わせください。
- P6 : 6ミリピッチ用

2.3mm (090)

Housing (UNIT : mm)

Ref: Terminal part No. B-08
ターミナル参照頁

Ref: wire seal No. B-10
ワイヤシール参照頁

Ref: Dummy plug No. B-11
ダミー栓参照頁

Material PBT
材質

2way

Color Gray
色相 灰

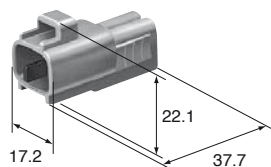

M (6188-0108)

F (6189-0199)

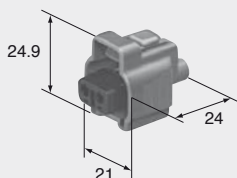

Color Gray
色相 灰

(P6)

(7160-9465)

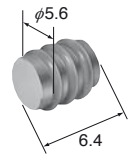

Material NBR
材質
Color Black
色相 黒

(P5)

(7161-9787)

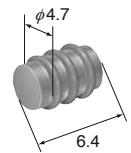

Material NBR
材質
Color Brown
色相 茶

2way

Color Gray
色相 灰

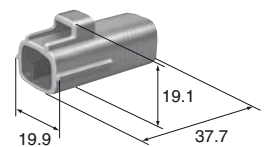

M (6188-0047)

F (6189-0100)

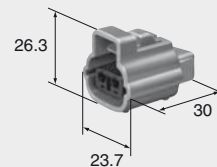

Color Gray
色相 灰

2way

Color Gray
色相 灰

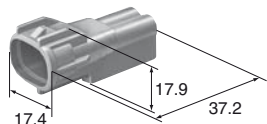

M (6188-0266)

F (6189-0249)

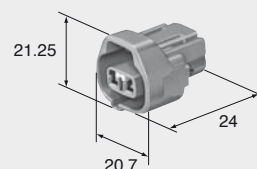

Color Gray
色相 灰

2way

Color 色相	Gray 灰
-------------	-----------

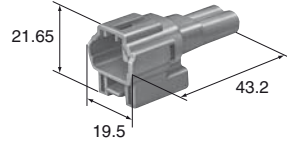
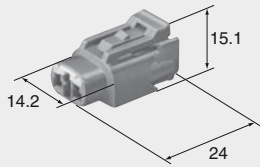
**M (6188-0229)****F (6189-0388)**

Color 色相	Gray 灰
-------------	-----------

2way

Color 色相	Natural 自然色
-------------	----------------

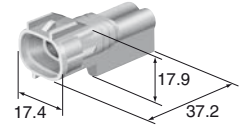
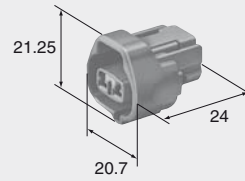
**M (6188-0624)****F (6189-0264)**

Color 色相	Gray 灰
-------------	-----------

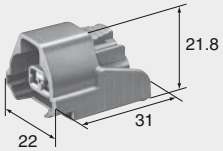
2way**P5****F (6189-0566)**

Ref: Wire seal No. ワイヤシール参照頁	B-10 (For P5)
---------------------------------	---------------

Ref: Dummy plug No. ダミー栓参照頁	B-11 (For P5)
--------------------------------	---------------

Color 色相	Gray 灰
-------------	-----------

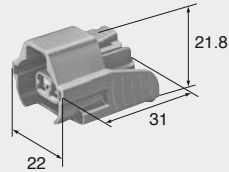
2way**P5****F (6189-0573)**

Ref: Wire seal No. ワイヤシール参照頁	B-10 (For P5)
---------------------------------	---------------

Ref: Dummy plug No. ダミー栓参照頁	B-11 (For P5)
--------------------------------	---------------

Color 色相	Gray 灰
-------------	-----------

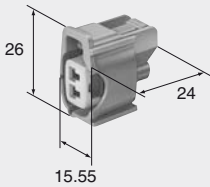
2way**P5****F (6189-0611)**

Ref: Wire seal No. ワイヤシール参照頁	B-10 (For P5)
---------------------------------	---------------

Ref: Dummy plug No. ダミー栓参照頁	B-11 (For P5)
--------------------------------	---------------

Color 色相	Gray 灰
-------------	-----------

2way

Color 色相	Gray 灰
-------------	-----------

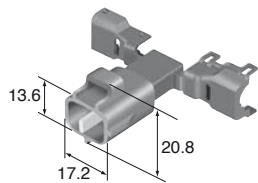
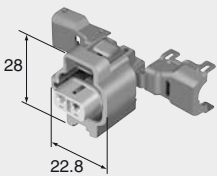
**M (6188-0470)****F (6189-0682)**

Color 色相	Gray 灰
-------------	-----------

3way (T Type)

Color 色相	Gray 灰
-------------	-----------

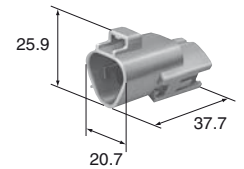
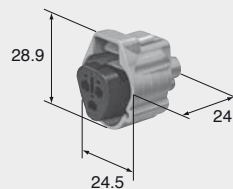
**M (6188-0099)****F (6189-0179)**

Color 色相	Gray 灰
-------------	-----------

4way

F (6189-0694)

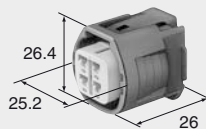

Color 色相: Black 黒

3way (E Type)

Color 色相: Gray 灰

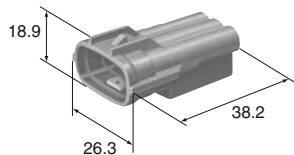

M (6188-0282) F (6189-0443)

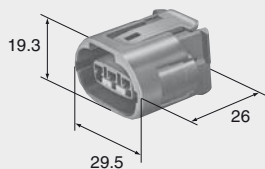

Color 色相: Gray 灰

4way

Color 色相: Black 黒

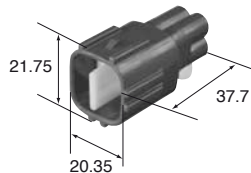

M (6188-0517) F (6189-0629)

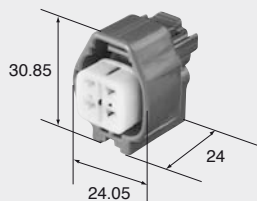

Color 色相: Gray 灰

4way

Color 色相: Gray 灰

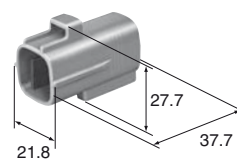

M (6188-0066) F (6189-0126)

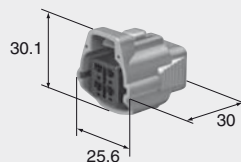

Color 色相: Gray 灰

4way

Color 色相: Gray 灰

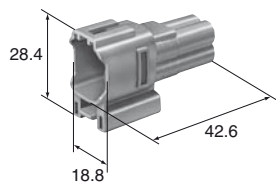

M (6188-0141) F (6189-0381)

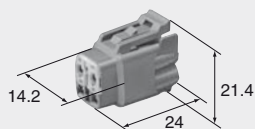

Color 色相: Gray 灰

4way

Color 色相: Gray 灰

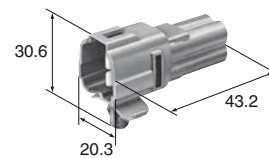
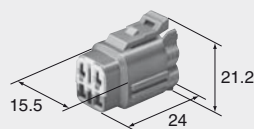

Plate thickness range for clamp: t=0.7~2.2

M (6188-0217) F (6189-0372)



Color 色相: Gray 灰

B-13
TS SEALED SERIES

4way

Color 色相 Gray 灰

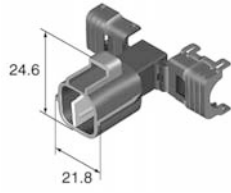
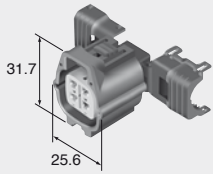
**M (6188-0472)****F (6189-0685)**

Color 色相 Gray 灰

5way

Color 色相 Gray 灰

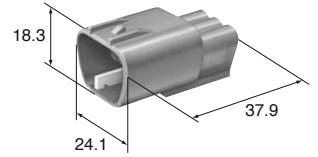
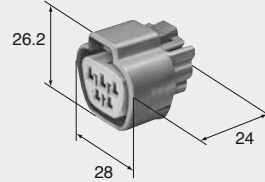
**M (6188-0327)****F (6189-0504)**

Color 色相 Gray 灰

6way

Color 色相 Gray 灰

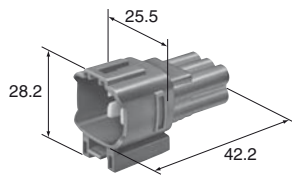
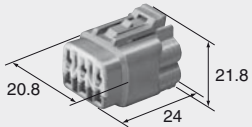
**M (6188-0173)****F (6189-0319)**

Color 色相 Gray 灰

6way

Color 色相 Gray 灰

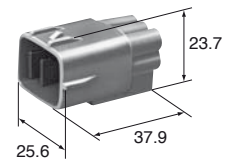
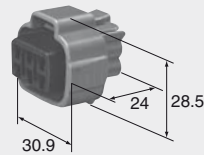
**M (6188-0175)****F (6189-0323)**

Color 色相 Gray 灰

6way

Color 色相 Gray 灰

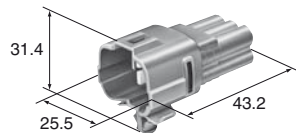
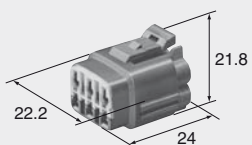

Plate thickness range for clamp:
t=0.7~2.2

M (6188-0209)**F (6189-0368)**

Color 色相 Gray 灰

7way

Color 色相 Gray 灰

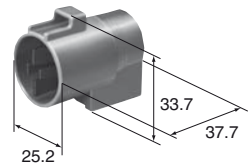
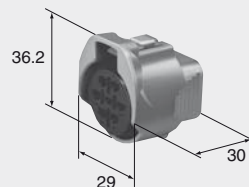
**M (6188-0067)****F (6189-0127)**

Color 色相 Gray 灰

TS SEALED SERIES for STANDARD

4.8mm (187)

Structure / 構造

B-15

TS SEALED SERIES

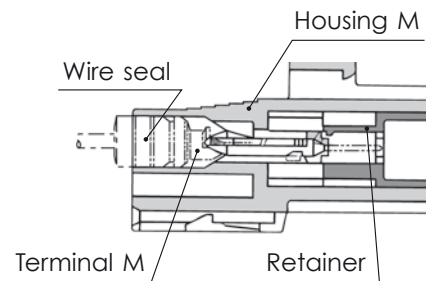
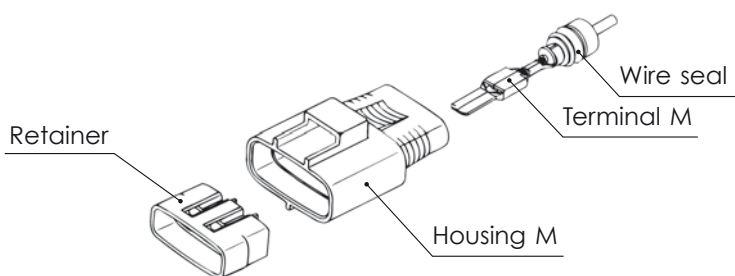

Connector M

Connector F

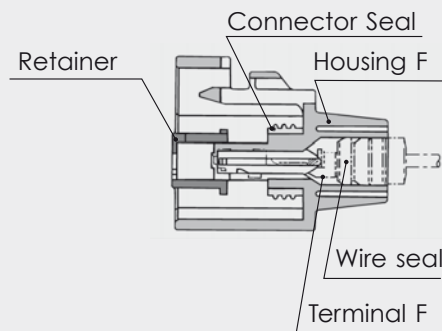
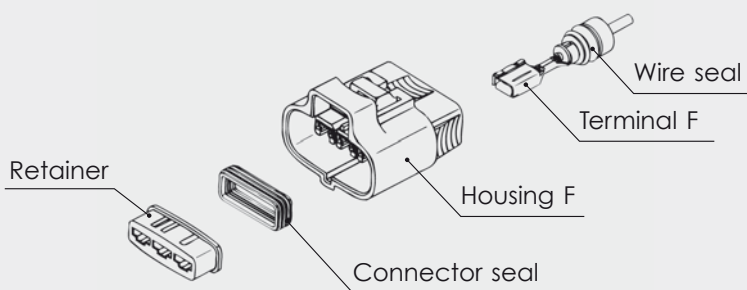

4.8mm (187)

(S)

Cable size (mm ²) 適用電線サイズ	0.3~0.5
Material 材質	Brass 黄銅
Surface treatment 表面処理	Tin-plated Snメッキ

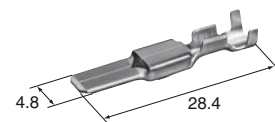

M (8100-0463)

F (8100-0466)

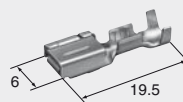

Cable size (mm ²) 適用電線サイズ	0.3~0.5
Material 材質	Brass 黄銅
Surface treatment 表面処理	Tin-plated Snメッキ

Terminal (UNIT : mm)

(M)

Cable size (mm ²) 適用電線サイズ	0.5~1.25
Material 材質	Brass 黄銅
Surface treatment 表面処理	Tin-plated Snメッキ

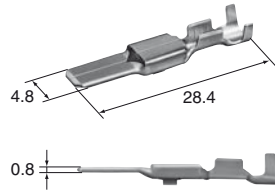
**(L)**

Cable size (mm ²) 適用電線サイズ	2.0~3.0
Material 材質	Brass 黄銅
Surface treatment 表面処理	Tin-plated Snメッキ

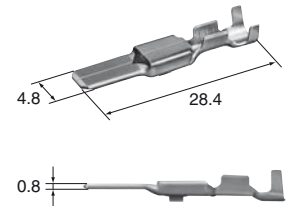

B-16

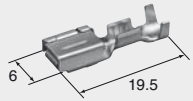
M (8100-0464)**F (8100-0467)**

Cable size (mm ²) 適用電線サイズ	0.5~1.25
Material 材質	Brass 黄銅
Surface treatment 表面処理	Tin-plated Snメッキ

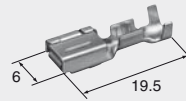
M (8100-0465)**F (8100-0468)**

Cable size (mm ²) 適用電線サイズ	2.0~3.0
Material 材質	Heat-resistant copper alloy
Surface treatment 表面処理	Tin-plated Snメッキ

4.8mm (187)**Wire seals (UNIT : mm)**

The wire seals are common to M and F.

ワイヤシールはM、F共用です。

(S)**(7165-0346)**

Cable size (mm ²) 適用電線サイズ	(AVS/0.3) (AVSS/0.3~0.85) (AVSSX•AESSX/0.5~0.75) (CAVUS/0.85~1.25)
Cable overall diameter (mm) 電線仕上り外径	1.4~2.0
Material 材質	Silicon シリコン
Color 色相	Dark Brown 濃茶

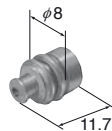
**(M)****(7165-0347)**

Cable size (mm ²) 適用電線サイズ	(AV/0.5~1.25) (AVX•AEX/0.5~1.25) (AVS/0.5~1.25) (AVSS/1.25~2.0) (AVSSX•AESSX/1.25~2.0)
Cable overall diameter (mm) 電線仕上り外径	2.0~2.9
Material 材質	Silicon シリコン
Color 色相	Dark Green 濃緑

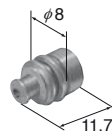
**(L)****(7165-0348)**

Cable size (mm ²) 適用電線サイズ	(AV/2.0) (AVX•AEX/2.0) (AVS/2.0)
Cable overall diameter (mm) 電線仕上り外径	2.9~3.5
Material 材質	Silicon シリコン
Color 色相	Dark Gray 濃灰

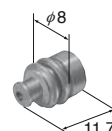
**(LL)****(7165-0356)**

Cable size (mm ²) 適用電線サイズ	(AV/3.0) (AVX•AEX/3.0) (AVS/3.0)
Cable overall diameter (mm) 電線仕上り外径	3.5~4.1
Material 材質	Silicon シリコン
Color 色相	Dark Blue 紺

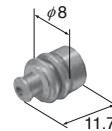

4.8mm (187)

Dummy plugs (UNIT: mm)

- Dummy plugs are common to M and F.
- Dummy plugs are used to blind unused terminal holes.
- ダミー栓はM、F共用です。
- 不必要なターミナル穴を塞ぐために、ダミー栓を使用します。

(7165-0145)

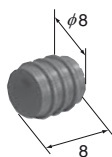

Material 材質	NBR
Color 色相	Gray 灰

4.8mm (187)

Housing (UNIT: mm)

Ref: Terminal part No. ターミナル参照頁	B-15
Ref: wire seal No. ワイヤシール参照頁	B-16
Ref: Dummy plug No. ダミー栓参照頁	B-17
Material 材質	PBT

1way

Color 色相	Gray 灰
-------------	-----------

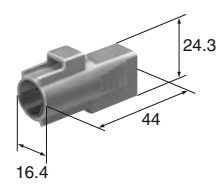

M (6188-0083) F (6189-0145)

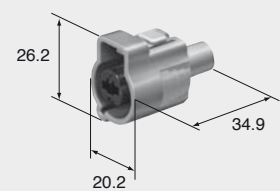

Color 色相	Gray 灰
-------------	-----------

1way

F (6189-0413)

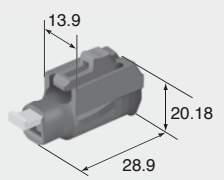

Color 色相	Black 黒
-------------	------------

2way

Color 色相	Gray 灰
-------------	-----------

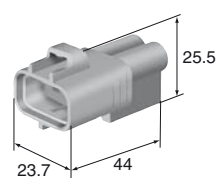

M (6188-0259) F (6189-0425)

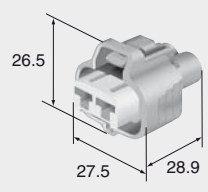

Color 色相	Gray 灰
-------------	-----------

3way

Color Gray
色 相 灰

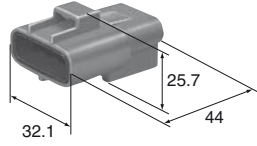

B-18

M (6188-0129)

F (6189-0165)

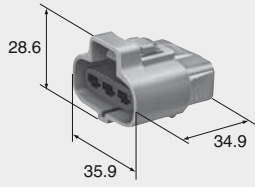

Color Gray
色 相 灰

TS SEALED SERIES for STANDARD

8.0mm (312)

Structure / 構造

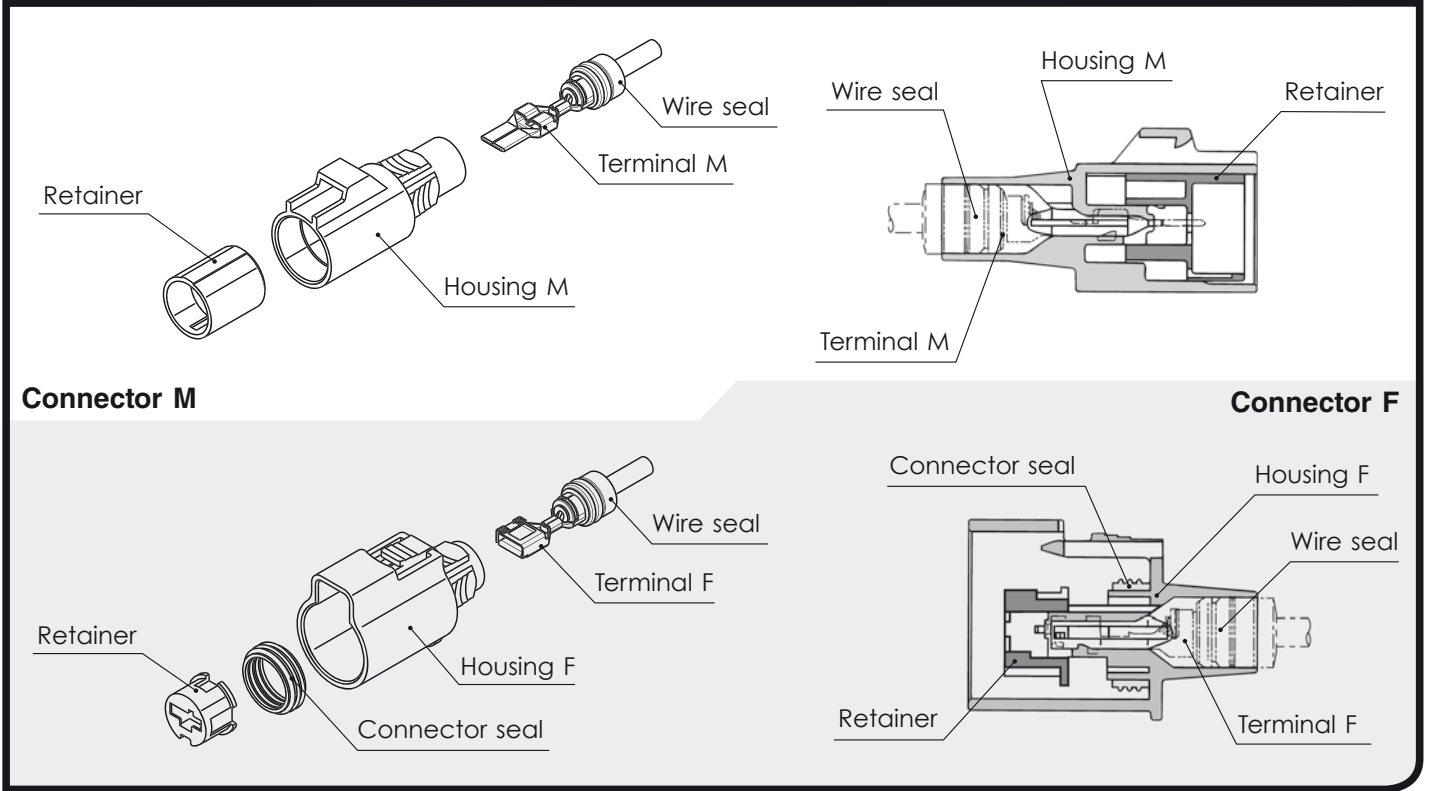

B-19
TS SEALED SERIES

8.0mm (312)

(S)

Cable size (mm ²) 適用電線サイズ	0.5~1.25
Cable overall diameter (mm) 電線仕上りサイズ	2.0~2.7
Material 材質	Brass 黄銅
Surface treatment 表面処理	Tin-plated Snメッキ

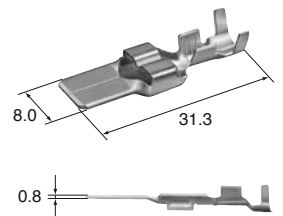

M (8100-0506)

F (8100-0451)

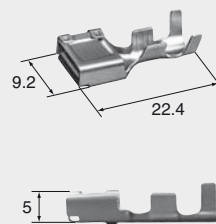

Cable size (mm ²) 適用電線サイズ	0.5~1.25
Cable overall diameter (mm) 電線仕上りサイズ	2.0~2.7
Material 材質	Brass 黄銅
Surface treatment 表面処理	Tin-plated Snメッキ

Terminal (UNIT : mm)

(M)Cable size (mm²) 2.0~3.0

適用電線サイズ

Cable overall diameter (mm) 2.6~4.1

電線仕上りサイズ

Material Brass

材質

黄銅

Surface treatment Tin-plated

表面処理

Snメッキ

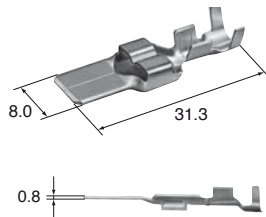
**(L)**Cable size (mm²) 5.0~8.0

適用電線サイズ

Cable overall diameter (mm) 4.4~5.8

電線仕上りサイズ

Material Brass

材質

黄銅

Surface treatment Tin-plated

表面処理

Snメッキ

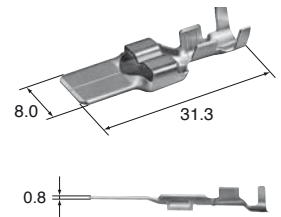

B-20

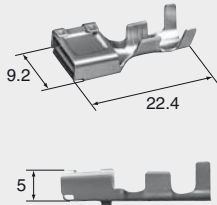
M (8100-0507)**F (8100-0452)**Cable size (mm²) 2.0~3.0

適用電線サイズ

Cable overall diameter (mm) 2.6~4.1

電線仕上りサイズ

Material Brass

材質

黄銅

Surface treatment Tin-plated

表面処理

Snメッキ

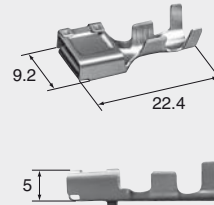
M (8100-0508)**F (8100-2980)**Cable size (mm²) 5.0~8.0

適用電線サイズ

Cable overall diameter (mm) 4.4~5.8

電線仕上りサイズ

Material Heat-resistant copper alloy

材質

Heat-resistant copper alloy

Surface treatment Tin-plated

表面処理

Snメッキ

8.0mm (312)**Wire seals (UNIT : mm)**

The wire seals are common to M and F.

ワイヤシールはM、F共用です。

(SS)**(7165-0683)**Cable size (mm²) (AVS·AVX/0.5~1.25)

適用電線サイズ

Cable overall diameter (mm) Over 2.0 mm less than 2.9 mm

電線仕上り外径

2.0 mmを越え2.9 mm以下

Material Silicon

材質

シリコン

Color Dark Brown

色相

濃茶

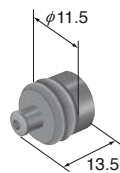
**(S)****(7165-0400)**Cable size (mm²) (AV/3.0) (AVX·AEX/3.0) (AVS/3.0)

適用電線サイズ

Cable overall diameter (mm) 3.6~4.1

電線仕上り外径

Material Silicon

材質

シリコン

Color Dark Gray

色相

濃灰

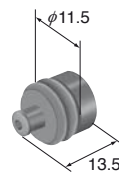
**(M)****(7165-0392)**Cable size (mm²) (AV/5.0) (AVX·AEX/5.0) (AVS/5.0)

適用電線サイズ

Cable overall diameter (mm) 4.4~4.9

電線仕上り外径

Material Silicon

材質

シリコン

Color Dark Blue

色相

紺

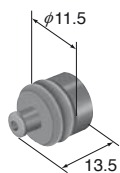
**(L)****(7165-0393)**Cable size (mm²) (AV/8.0) (AVX·AEX/8.0) (AVS/8.0)

適用電線サイズ

Cable overall diameter (mm) 5.3~5.8

電線仕上り外径

Material Silicon

材質

シリコン

Color Black

色相

黒

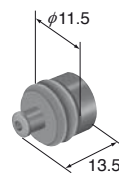

8.0mm (312)

Dummy plugs (UNIT : mm)

- Dummy plugs are common to M and F.
- Dummy plugs are used to blind unused terminal holes.
- ダミー栓はM、F共用です。
- 不必要なターミナル穴を塞ぐために、ダミー栓を使用します。

8.0mm (312)

Housing (UNIT : mm)

Ref: Terminal part No. B-19
ターミナル参照頁

Ref: wire seal No. B-20
ワイヤシール参照頁

Ref: Dummy plug No. B-21
ダミー栓参照頁

Material PBT
材質

(7165-0180)

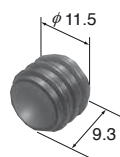

Material 材質	NBR
Color 色相	Gray 灰

1way

Color 色相	Gray 灰
-------------	-----------

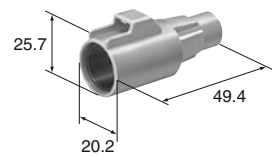

M (6188-0049)

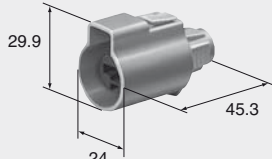

F (6189-0101)

Color 色相	Gray 灰
-------------	-----------

2way

F (6189-0856)

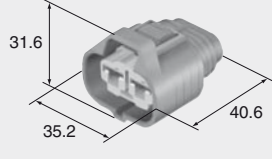

Color 色相	Gray 灰
-------------	-----------

2way

F (6189-6953)

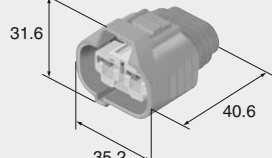

Color 色相	Gray 灰
-------------	-----------

2way

Color 色相	Gray 灰
-------------	-----------

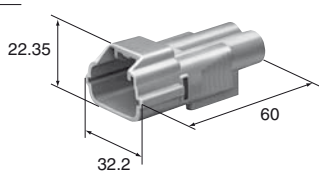

M (6188-0096)

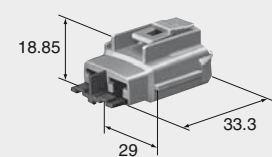

F (6189-0172)

Color 色相	Gray 灰
-------------	-----------

TS SEALED SERIES for HYBRID

0.64mm, 2.3mm
(025, 090)

Housing (UNIT : mm)

Ref: Terminal part No.	[0.64mm]	B-03
ターミナル参照頁	[2.3mm]	B-08

Ref: wire seal No.	[0.64mm]	B-04
ワイヤシール参照頁	[2.3mm]	B-10

Ref: Dummy plug No.	[0.64mm]	B-04
ダミー栓参照頁	[2.3mm]	B-11

Material	PBT
材質	

No. of way/ () corresponds to 0.64mm, 2.3mm, in order from left to right.
極数 / () 内表示 : 左から 0.64mm 極数、2.3mm 極数

10way (6+4) **F (6189-1163)**

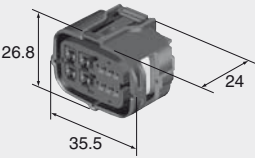

Color	Black
色相	黒

13way (10+3) **F (6189-7077)**

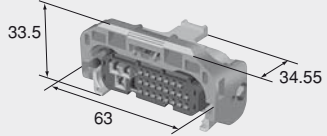

Color	Gray
色相	灰

26way (23+3) **F (6189-6934)**

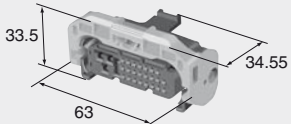

Color	Black
色相	黒

0.64mm, 4.8mm
(025, 187)

Housing (UNIT : mm)

Ref: Terminal part No.	[0.64mm]	B-03
ターミナル参照頁	[4.8mm]	B-15
Ref: wire seal No.	[0.64mm]	B-04
ワイヤシール参照頁	[4.8mm]	B-16
Ref: Dummy plug No.	[0.64mm]	B-04
ダミー栓参照頁	[4.8mm]	B-17
Material	PBT	
材質		

No. of way () corresponds to 0.64mm, 4.8mm, in order from left to right.
極数 / () 内表示 : 左から 0.64mm 極数、4.8mm 極数

4way (2+2)

Color	Black
色相	黒

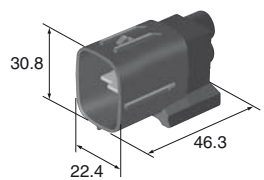

M (6188-5103) **F (6189-1048)**

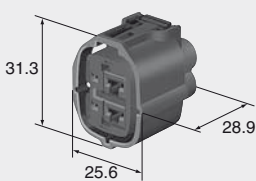

Color	Black
色相	黒

34way (30+4) **F (6189-6978)**

Color: Black
色相: 黒

34way (30+4) **F (6189-6979)**

Color: Gray
色相: 灰

34way (30+4) **F (6189-6980)**

Color: Black
色相: 黒

34way (30+4) **F (6189-6981)**

Color: Gray
色相: 灰

40way (36+4) **F (6189-1160)**

Color: Gray
色相: 灰

46way (42+4) **F (6189-1136)**

Color: Black
色相: 黒

46way (42+4) **F (6189-6894)**

Color: Black
色相: 黒

**0.64mm, 2.3mm, 4.8mm
(025, 090, 187)**

Housing (UNIT : mm)

Ref: Terminal part No. ターミナル参照頁	[0.64mm] [2.3mm] [4.8mm]	B-03 B-08 B-15
Ref: wire seal No. ワイヤシール参照頁	[0.64mm] [2.3mm] [4.8mm]	B-04 B-10 B-16
Ref: Dummy plug No. タミー栓参照頁	[0.64mm] [2.3mm] [4.8mm]	B-04 B-11 B-17
Material 材質	PBT	

No. of way/ () corresponds to 0.64mm, 2.3mm, 4.8mm in order from left to right.
極数 / () 内表示 : 左から 0.64mm 極数、2.3mm 極数、4.8mm 極数

42way (36+2+4) **F (6189-7094)**

Color: Black
色相: 黒

2.3mm, 4.8mm (090, 187)

Housing (UNIT : mm)

Ref: Terminal part No. [2.3mm] B-08
ターミナル参照頁 [4.8mm] B-15

Ref: wire seal No. [2.3mm] B-10 (For P6)
ワイヤシール参照頁 [4.8mm] B-16

Ref: Dummy plug No. [2.3mm] B-11 (For P6)
ダミー栓参照頁 [4.8mm] B-17

Material PBT
材質

No. of way/ () corresponds to 2.3mm, 4.8mm in order from left to right.
極数 / () 内表示 : 左から 2.3mm 極数、4.8mm 極数

4way (2+2)

Color Gray
色相 灰

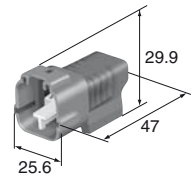

M (6188-0415)

F (6189-0144)

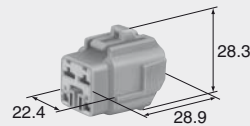

Color Gray
色相 灰

5way (3+2)

Color Gray
色相 灰

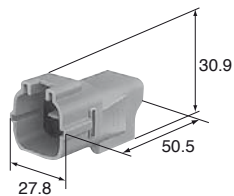

M (6188-0091)

F (6189-0166)

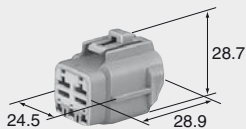

Color Gray
色相 灰

5way (3+2)

Color Gray
色相 灰

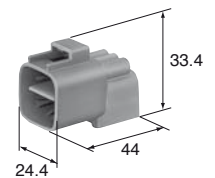

M (6188-0101)

F (6189-0181)

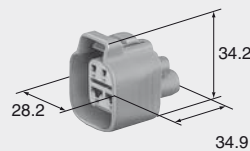

Color Gray
色相 灰

6way (4+2)

Color Gray
色相 灰

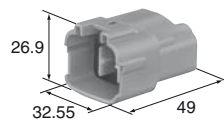

M (6188-0187)

F (6189-0143)

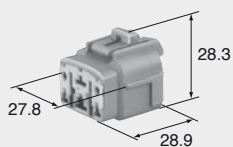

Color Gray
色相 灰

11way (8+3)

Color Gray
色相 灰



M (6188-0221)

F (6189-0376)

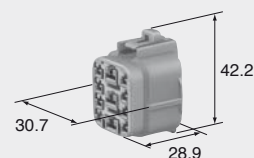

Color Gray
色相 灰

4.8mm, 8.0mm
(187, 312)

Housing (UNIT : mm)

Ref: Terminal part No.	[4.8mm] B-15
ターミナル参照頁	[8.0mm] B-19

Ref: wire seal No.	[4.8mm] B-16
ワイヤシール参照頁	[8.0mm] B-20

Ref: Dummy plug No.	[4.8mm] B-17
ダミー栓参照頁	[8.0mm] B-21

Material	PBT
材質	

No. of way/ () corresponds to 4.8mm, 8.0mm in order from left to right.
極数 / () 内表示 : 左から 4.8mm 極数、8.0mm 極数

3way (1+2)

F (6189-7156)

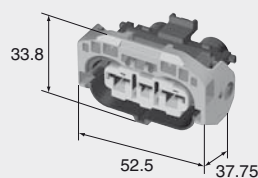

Color
色相

Black
黒

B-25

TS SEALED SERIES