

# TS SERIES

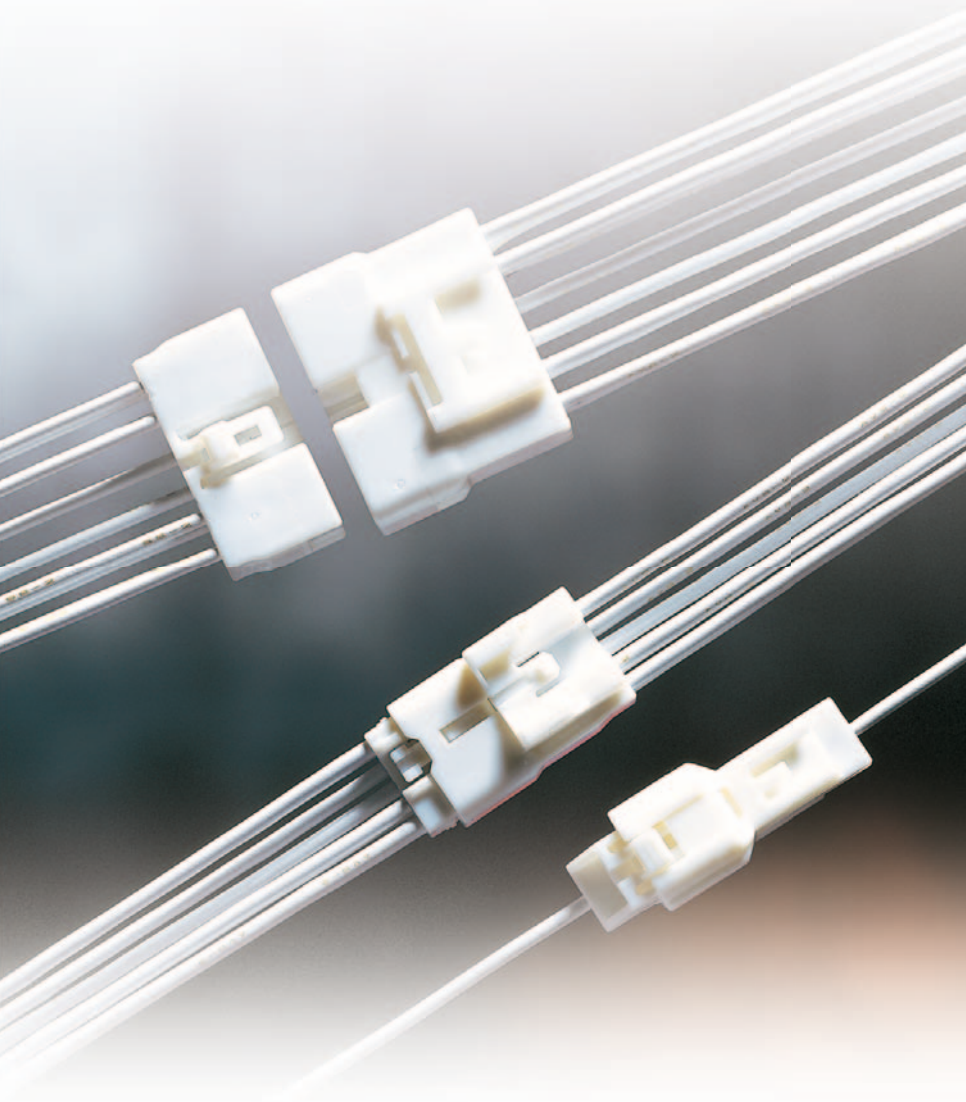

## Features

The TS connector series has a mechanism of terminal position assurance.

This series consists of 0.64mm, 1.5mm, 2.3mm, 4.8mm and 8.0mm types classified according to terminal size, covering an extensive array of applications from signal to power circuits.

- The connector mechanism only allows the retainer to be set when the terminal is completely inserted.
- Retainers are pre-mounted on connector housings, and are structured to enable setting by the same simple operation regardless of the number of ways, improving operability.
- These connectors can be directly secured to a support on the car body.
- PCB models are also available for connection to printed circuit boards.
- RoHS/ELV Compliant

## 特長

TSシリーズは、挿入不足のターミナルを検知する機構を備えたコネクタシリーズです。

ターミナルサイズにより0.64mm・1.5mm・2.3mm・4.8mm・8.0mmで構成されており、信号回路からパワー回路まで幅広くご利用いただけます。

- ターミナルが半挿入の状態では、リテーナが装着できない機構になっています。
- リテーナはコネクタハウジングに予め組み付けられており、また極数に関係なく簡単な同一作業でセットすることができる構造になっているので、作業性が向上します。
- コネクタは、ボデー側のブラケットに直接固定することができます。
- プリント基板との接続に適したPCBタイプも設定いたしました。
- RoHS/ELV対応

# TS SERIES for STANDARD

0.64mm (025)

A-02

Structure / 構造

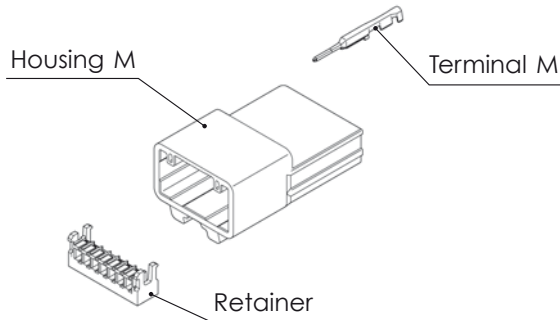

Connector M

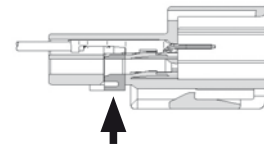

Retainer sliding direction

リテーナを押込むことにより、端子の半挿入状態を検知できます。

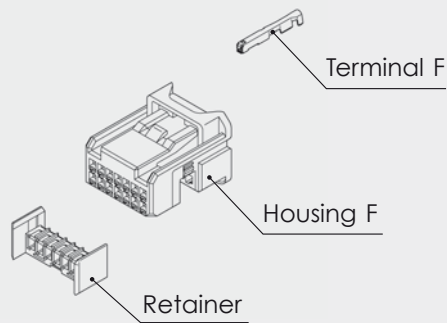

Connector F

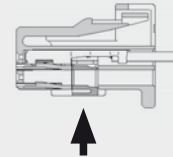

Retainer sliding direction

リテーナを押込むことにより、端子の半挿入状態を検知できます。

0.64mm (025)

Terminal (UNIT : mm)

**(S)**

Cable size (mm <sup>2</sup> ) 適用電線サイズ	0.13
Material 材質	Brass 黄銅
Surface treatment 表面処理	Tin-plated Snメッキ

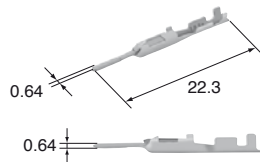
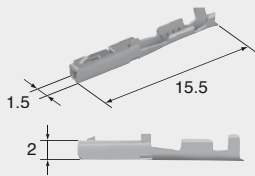
**M (8230-4878)**

Cable size (mm <sup>2</sup> ) 適用電線サイズ	0.13
Material 材質	Heat-resistant copper alloy
Surface treatment 表面処理	Tin-plated Snメッキ

**F (8240-0182)****(S)**

Cable size (mm <sup>2</sup> ) 適用電線サイズ	0.13
Material 材質	Brass 黄銅
Surface treatment 表面処理	Gold-plated Auメッキ

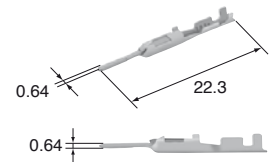
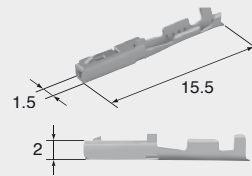
**M (8230-5136)**

Cable size (mm <sup>2</sup> ) 適用電線サイズ	0.13
Material 材質	Heat-resistant copper alloy
Surface treatment 表面処理	Gold-plated Auメッキ

**F (8240-0338)****(M)**

Cable size (mm <sup>2</sup> ) 適用電線サイズ	0.22~0.35
Material 材質	Brass 黄銅
Surface treatment 表面処理	Tin-plated Snメッキ

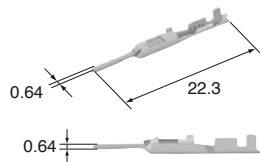
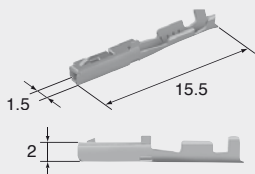
**M (8100-3622)**

Cable size (mm <sup>2</sup> ) 適用電線サイズ	0.22~0.35
Material 材質	Heat-resistant copper alloy
Surface treatment 表面処理	Tin-plated Snメッキ

**F (8100-3624)****(M)**

Cable size (mm <sup>2</sup> ) 適用電線サイズ	0.22~0.35
Material 材質	Brass 黄銅
Surface treatment 表面処理	Gold-plated Auメッキ

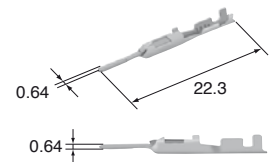
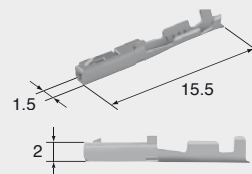
**M (8100-3626)**

Cable size (mm <sup>2</sup> ) 適用電線サイズ	0.22~0.35
Material 材質	Heat-resistant copper alloy
Surface treatment 表面処理	Gold-plated Auメッキ

**F (8100-3628)****(L)**

Cable size (mm <sup>2</sup> ) 適用電線サイズ	0.3~0.5
Material 材質	Brass 黄銅
Surface treatment 表面処理	Tin-plated Snメッキ

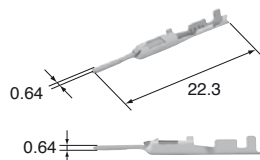
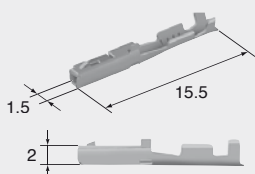
**M (8100-3623)**

Cable size (mm <sup>2</sup> ) 適用電線サイズ	0.3~0.5
Material 材質	Heat-resistant copper alloy
Surface treatment 表面処理	Tin-plated Snメッキ

**F (8100-3625)****(L)**

Cable size (mm <sup>2</sup> ) 適用電線サイズ	0.3~0.5
Material 材質	Brass 黄銅
Surface treatment 表面処理	Gold-plated Auメッキ

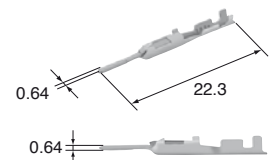
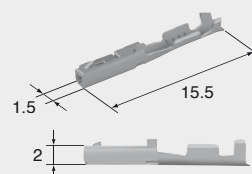
**M (8100-3627)**

Cable size (mm <sup>2</sup> ) 適用電線サイズ	0.3~0.5
Material 材質	Heat-resistant copper alloy
Surface treatment 表面処理	Gold-plated Auメッキ

**F (8100-3629)****Au****Au****Au**

A-03

TS SERIES

# 0.64mm (025)

## Housing (UNIT : mm)

Ref: Terminal part No. A-02  
ターミナル参照頁

Material PBT  
材質

### 2way

Color Natural  
色相 自然色

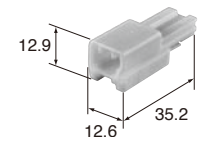

### M (6098-6653)

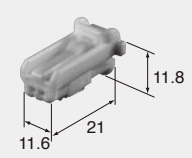

### F (6098-6662)

Color Natural  
色相 自然色

### 5way

Color Natural  
色相 自然色

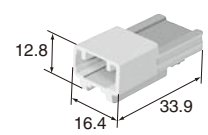

### M (6098-3802)

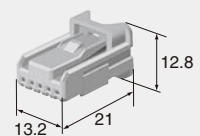

### F (6098-3810)

Color Natural  
色相 自然色

### 10way

Color Natural  
色相 自然色

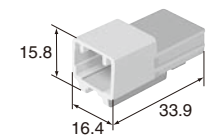

### M (6098-3869)

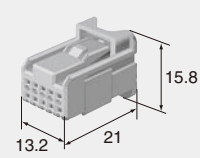

### F (6098-3909)

Color Natural  
色相 自然色

### 14way

Color Natural  
色相 自然色

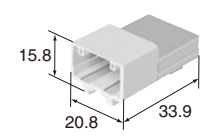

### M (6098-3877)

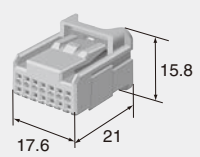

### F (6098-3917)

Color Natural  
色相 自然色

### 14way

### F (6098-7241)

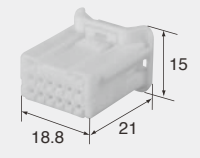

Color Natural  
色相 自然色

**16way**

Color 色相 Natural 自然色

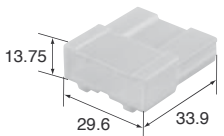

**M (6098-7336)** **F (6098-4008)**

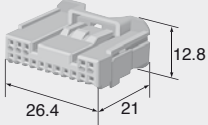

Color 色相 Natural 自然色

**16way** **F (6098-6688)**



Color 色相 Natural 自然色

**16way** **F (6098-6694)**

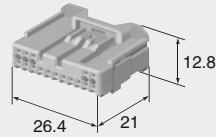

Color 色相 Natural 自然色

**19way** **F (6098-7231)**

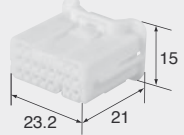

Color 色相 Natural 自然色

**22way**

Color 色相 Natural 自然色

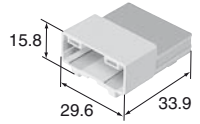

**M (6098-3885)** **F (6098-3925)**

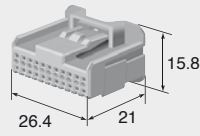

Color 色相 Natural 自然色

**24way** **F (6098-4010)**

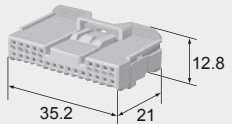

Color 色相 Natural 自然色

**24way** **F (6098-6682)**

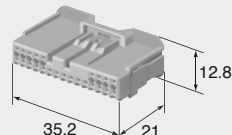

Color 色相 Natural 自然色

**28way** **F (6098-4756)**

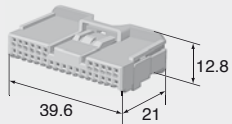

Color 色相 Natural 自然色

**32way** **F (6098-4013)**

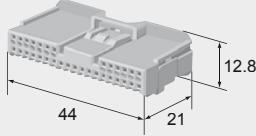

Color 色相 Natural 自然色

**36way**

**F (6098-4740)**

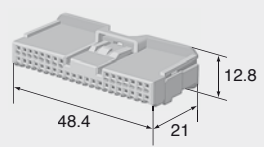

Color  
色 相

Natural  
自然色

**40way**

**F (6098-4015)**

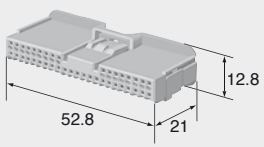

Color  
色 相

Natural  
自然色

**40way**

**F (6098-4831)**

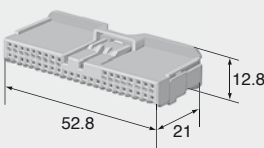

Color  
色 相

Natural  
自然色

# TS SERIES for STANDARD

1.5mm (060)

Structure / 構造

A-07

TS SERIES

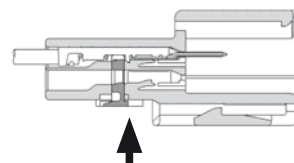
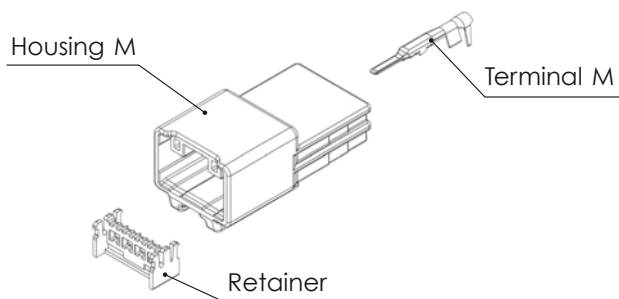

**Retainer sliding direction**

リテーナを押込むことにより、端子の半挿入状態を検知できます。

**Connector M**

**Connector F**

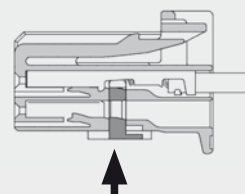
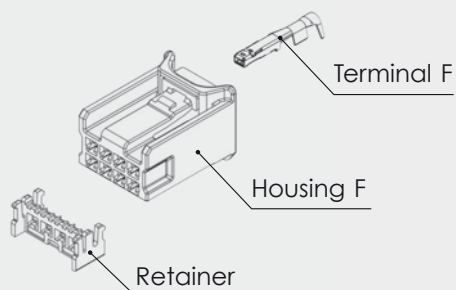

**Retainer sliding direction**

リテーナを押込むことにより、端子の半挿入状態を検知できます。

# 1.5mm (060)

A-08

## Terminal (UNIT : mm)

(3S)

F (8240-0339)

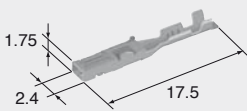

Cable size (mm <sup>2</sup> ) 適用電線サイズ	0.13
Material 材質	Heat-resistant copper alloy
Surface treatment 表面処理	Tin-plated Snメッキ

(SS)

F (8240-0279)

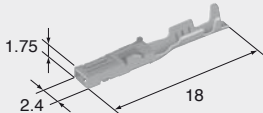

Cable size (mm <sup>2</sup> ) 適用電線サイズ	0.22~0.35
Material 材質	Heat-resistant copper alloy
Surface treatment 表面処理	Tin-plated Snメッキ

(M)

Cable size (mm <sup>2</sup> ) 適用電線サイズ	0.75~1.25
Material 材質	Brass 黄銅
Surface treatment 表面処理	Tin-plated Snメッキ

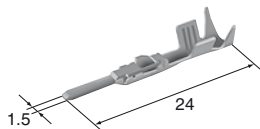

M (8230-4924)

F (8240-0213)

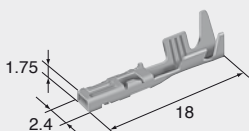

Cable size (mm <sup>2</sup> ) 適用電線サイズ	0.75~1.25
Material 材質	Heat-resistant copper alloy
Surface treatment 表面処理	Tin-plated Snメッキ

(S)

Cable size (mm <sup>2</sup> ) 適用電線サイズ	0.3~0.5
Material 材質	Brass 黄銅
Surface treatment 表面処理	Tin-plated Snメッキ

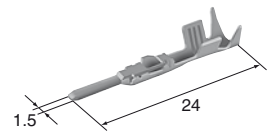

M (8230-4925)

F (8240-0215)

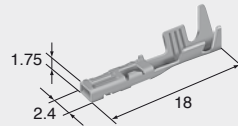

Cable size (mm <sup>2</sup> ) 適用電線サイズ	0.3~0.5
Material 材質	Heat-resistant copper alloy
Surface treatment 表面処理	Tin-plated Snメッキ

(L)

Cable size (mm <sup>2</sup> ) 適用電線サイズ	2.0
Material 材質	Heat-resistant copper alloy
Surface treatment 表面処理	Tin-plated Snメッキ

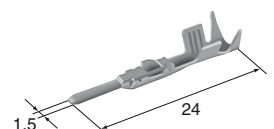

M (8230-4923)

F (8240-0214)

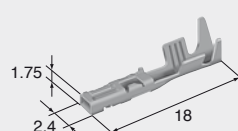

Cable size (mm <sup>2</sup> ) 適用電線サイズ	2.0
Material 材質	Heat-resistant copper alloy
Surface treatment 表面処理	Tin-plated Snメッキ



# 1.5mm (060)

## Housing (UNIT : mm)

Ref: Terminal part No. A-08  
ターミナル参照頁

Material PBT  
材質

### 2way

Color Natural  
色相 自然色

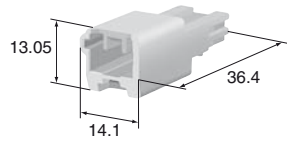

M (6098-6050)

F (6098-6053)

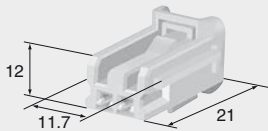

Color Natural  
色相 自然色

### 4way

Color Natural  
色相 自然色

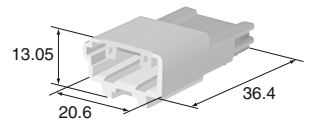

M (6098-5668)

F (6098-5677)

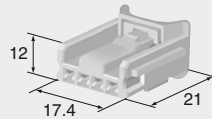

Color Natural  
色相 自然色

### 8way

Color Natural  
色相 自然色

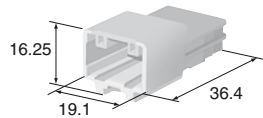

M (6098-5686)

F (6098-5695)

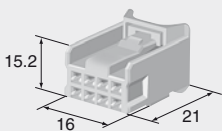

Color Natural  
色相 自然色

### 12way

Color Natural  
色相 自然色

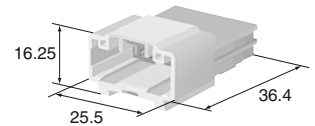

M (6098-5704)

F (6098-5713)

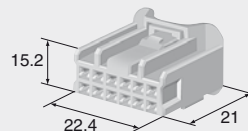

Color Natural  
色相 自然色

# TS SERIES for STANDARD

## 2.3mm (090)

A-10

Structure / 構造

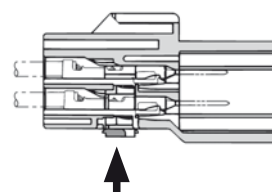
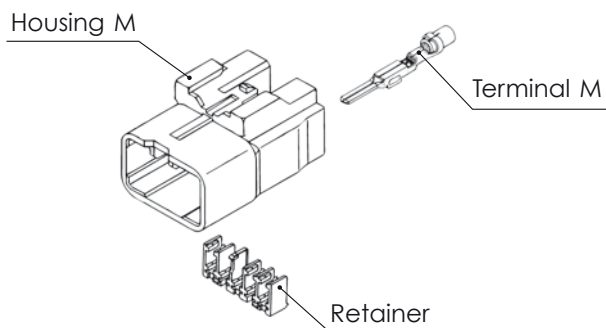

Retainer sliding direction

リテーナを押込むことにより、端子の半挿入状態を検知できます。

Connector M

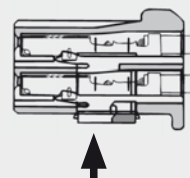
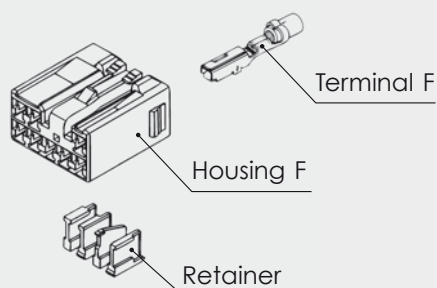

Retainer sliding direction

リテーナを押込むことにより、端子の半挿入状態を検知できます。

Connector F

2.3mm (090)

Terminal (UNIT : mm)

(SS)

Cable size (mm <sup>2</sup> ) 適用電線サイズ	0.22~0.35
Material 材質	Brass 黄銅
Surface treatment 表面処理	Tin-plated Snメッキ

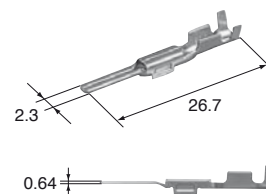

M (8230-4742)

F (8240-0029)

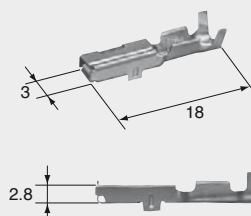

Cable size (mm <sup>2</sup> ) 適用電線サイズ	0.22~0.35
Material 材質	Brass 黄銅
Surface treatment 表面処理	Tin-plated Snメッキ

(S)

Cable size (mm <sup>2</sup> ) 適用電線サイズ	0.3~0.5
Material 材質	Brass 黄銅
Surface treatment 表面処理	Tin-plated Snメッキ

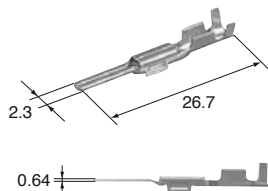

M (8230-4492)

F (8240-4882)

(S)

Au

Cable size (mm <sup>2</sup> ) 適用電線サイズ	0.3~0.5
Material 材質	Brass 黄銅
Surface treatment 表面処理	Gold-plated Auメッキ

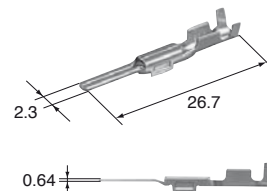

M (8100-1341)

F (8100-1346)

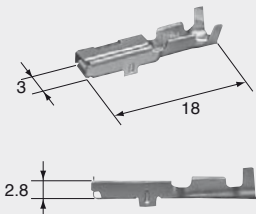

Cable size (mm <sup>2</sup> ) 適用電線サイズ	0.3~0.5
Material 材質	Brass 黄銅
Surface treatment 表面処理	Tin-plated Snメッキ

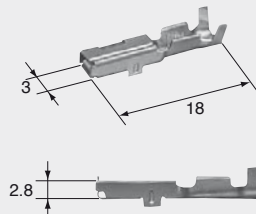

Cable size (mm <sup>2</sup> ) 適用電線サイズ	0.3~0.5
Material 材質	Brass 黄銅
Surface treatment 表面処理	Gold-plated Auメッキ

(M)

Cable size (mm <sup>2</sup> ) 適用電線サイズ	0.5~1.25
Material 材質	Brass 黄銅
Surface treatment 表面処理	Tin-plated Snメッキ

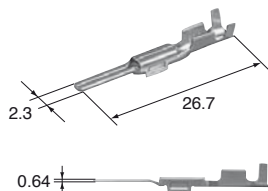

M (8230-4502)

F (8240-4892)

(M)

Au

Cable size (mm <sup>2</sup> ) 適用電線サイズ	0.5~1.25
Material 材質	Brass 黄銅
Surface treatment 表面処理	Gold-plated Auメッキ

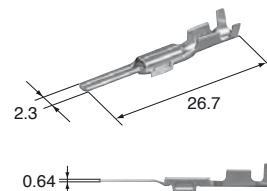

M (8100-1342)

F (8100-1347)

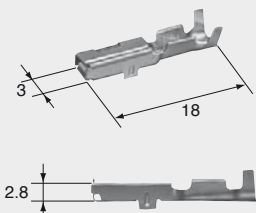

Cable size (mm <sup>2</sup> ) 適用電線サイズ	0.5~1.25
Material 材質	Brass 黄銅
Surface treatment 表面処理	Tin-plated Snメッキ

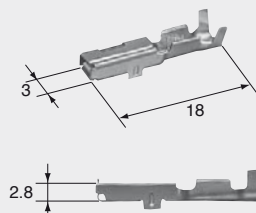

Cable size (mm <sup>2</sup> ) 適用電線サイズ	0.5~1.25
Material 材質	Brass 黄銅
Surface treatment 表面処理	Gold-plated Auメッキ

(L)

Cable size (mm <sup>2</sup> ) 適用電線サイズ	2.0
Material 材質	Brass 黄銅
Surface treatment 表面処理	Tin-plated Snメッキ

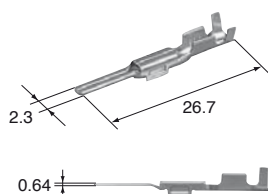

M (8230-4512)

F (8240-4942)

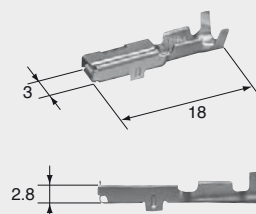

Cable size (mm <sup>2</sup> ) 適用電線サイズ	2.0
Material 材質	Heat-resistant copper alloy
Surface treatment 表面処理	Tin-plated Snメッキ

# 2.3mm (090)

## Housing (UNIT : mm)

Ref: Terminal part No. A-10  
ターミナル参照頁

**2way**

Material 材質	PA6T
Color 色相	Natural 自然色

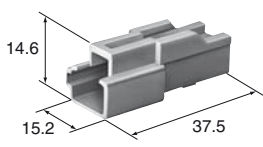

**M (6520-0549)**      **F (6520-0550)**

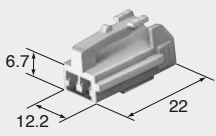

Material 材質	PA6T
Color 色相	Natural 自然色

**6way**

Material 材質	PBT
Color 色相	Natural 自然色
Note 備考	With clamp for 7mm dia. φ7用クランプ付

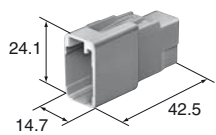
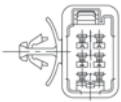

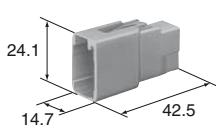
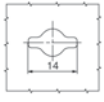

**M (6240-1107)**

Material 材質	PBT
Color 色相	Natural 自然色
Note 備考	With body fastening clamp. 回り止めクランプ付

**M (6249-1243)**      **F (6240-5118)**

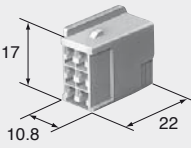

Material 材質	PBT
Color 色相	Natural 自然色

**6way**

**M (6240-1120)**

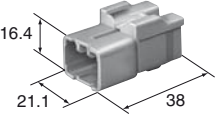

Material 材質	PBT
Color 色相	Natural 自然色

**9way**

Material 材質	PBT
Color 色相	Natural 自然色

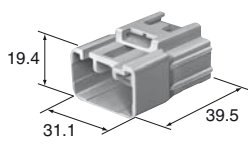

**8way**

**M (6240-1077)**

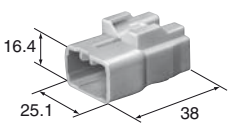

Material 材質	PBT
Color 色相	Natural 自然色

**M (6249-1229)**      **F (6248-5270)**

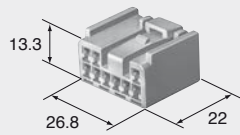

Material 材質	PBT
Color 色相	Natural 自然色

### 10way

Material 材質	PBT
Color 色相	Natural 自然色

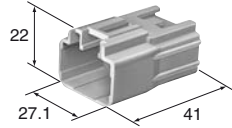

M (6249-1235)

F (6248-5276)

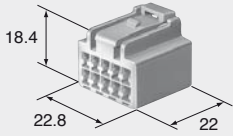

Material 材質	PBT
Color 色相	Natural 自然色

### 11way

Material 材質	PBT
Color 色相	Natural 自然色

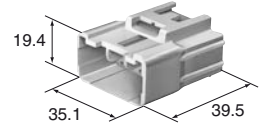

M (6249-1234)

F (6248-5275)

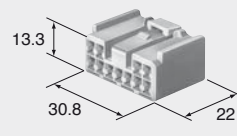

Material 材質	PBT
Color 色相	Natural 自然色

### 12way

Material 材質	PBT
Color 色相	Natural 自然色

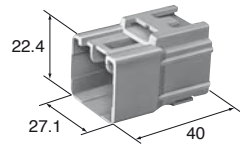

M (6520-1009)

F (6520-1004)

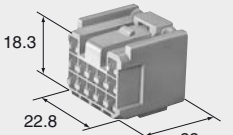

Material 材質	PBT
Color 色相	Natural 自然色

### 13way

Material 材質	PBT
Color 色相	Natural 自然色

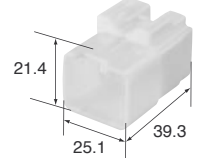

M (6240-1122)

F (6240-5175)

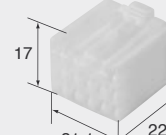

Material 材質	PBT
Color 色相	Natural 自然色

### 16way

Material 材質	PBT
Color 色相	Natural 自然色



M (6240-1158)

F (6240-5088)

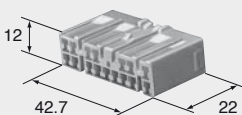

Material 材質	PBT
Color 色相	Natural 自然色

### 20way

Material 材質	PBT
Color 色相	Natural 自然色

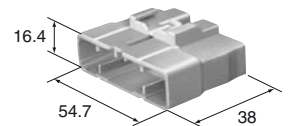

M (6240-1033)

F (6240-5035)

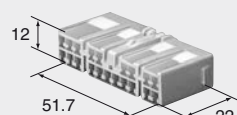

Material 材質	PBT
Color 色相	Natural 自然色

# TS SERIES for STANDARD

4.8mm (187)

A-14

Structure / 構造

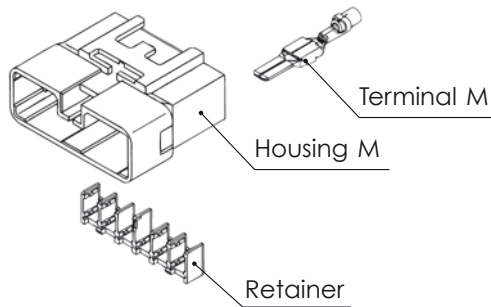

Connector M

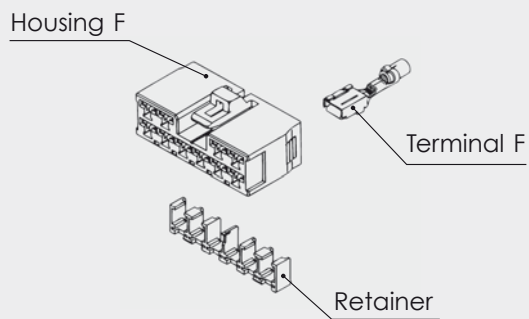

Connector F

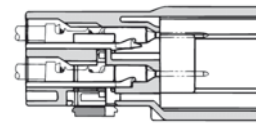

Retainer sliding direction

リテーナを押込むことにより、端子の半挿入状態を検知できます。

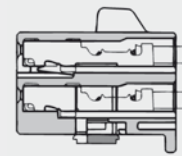

Retainer sliding direction

リテーナを押込むことにより、端子の半挿入状態を検知できます。

4.8mm (187)

Terminal (UNIT : mm)

**(S)**

Cable size (mm <sup>2</sup> ) 適用電線サイズ	0.3~0.5
Material 材質	Brass 黄銅
Surface treatment 表面処理	Tin-plated Snメッキ

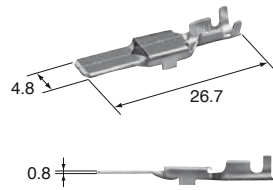
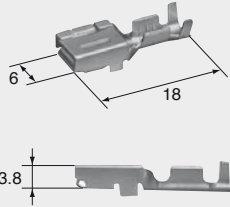
**M (8230-4522)****F (8240-4912)**

Cable size (mm <sup>2</sup> ) 適用電線サイズ	0.3~0.5
Material 材質	Brass 黄銅
Surface treatment 表面処理	Tin-plated Snメッキ

**(M)**

Cable size (mm <sup>2</sup> ) 適用電線サイズ	0.5~1.25
Material 材質	Brass 黄銅
Surface treatment 表面処理	Tin-plated Snメッキ

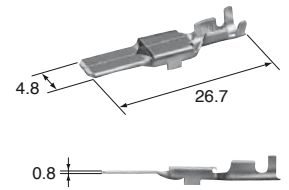
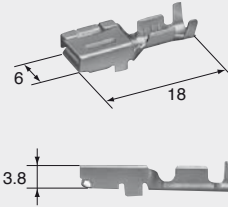
**M (8230-4532)****F (8240-4922)**

Cable size (mm <sup>2</sup> ) 適用電線サイズ	0.5~1.25
Material 材質	Brass 黄銅
Surface treatment 表面処理	Tin-plated Snメッキ

**(L)**

Cable size (mm <sup>2</sup> ) 適用電線サイズ	2.0~3.0
Material 材質	Brass 黄銅
Surface treatment 表面処理	Tin-plated Snメッキ

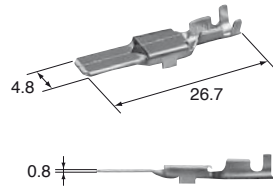
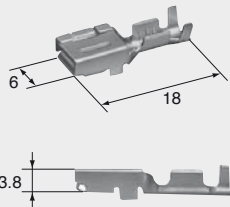
**M (8230-4542)****F (8240-4932)**

Cable size (mm <sup>2</sup> ) 適用電線サイズ	2.0~3.0
Material 材質	Brass 黄銅
Surface treatment 表面処理	Tin-plated Snメッキ

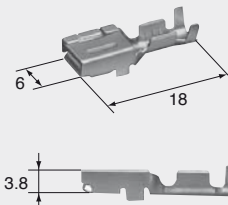
**(L)****F (8100-1555)**

Cable size (mm <sup>2</sup> ) 適用電線サイズ	2.0~3.0
Material 材質	Heat-resistant copper alloy
Surface treatment 表面処理	Tin-plated Snメッキ

**4.8mm (187)****Housing (UNIT : mm)**

Ref: Terminal part No. A-14  
ターミナル参照頁

Material PBT  
材質

**1way**

Color Natural  
色相 自然色

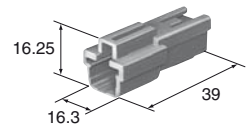
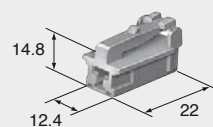
**M (6098-0822)****F (6098-0824)**

Color Natural  
色相 自然色

**2way**

Color 色相 Natural 自然色

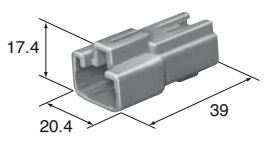

**M (6098-0323)**

**F (6098-0325)**

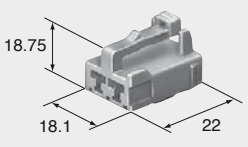

Color 色相 Natural 自然色

**2way**

Color 色相 Natural 自然色

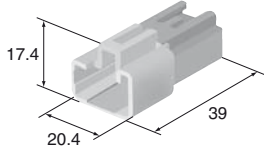

**M (6098-0469)**

**F (6098-0471)**

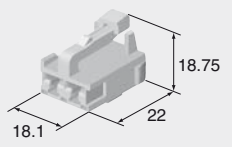

Color 色相 Natural 自然色

**3way**

Color 色相 Natural 自然色

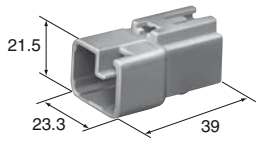

**M (6098-0149)**

**F (6098-0151)**

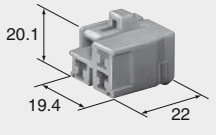

Color 色相 Natural 自然色

**4way**

Color 色相 Natural 自然色

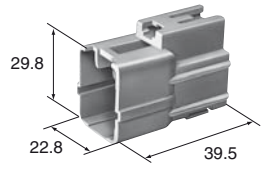

**M (6098-1851)**

**F (6098-1489)**

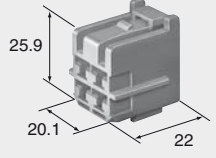

Color 色相 Natural 自然色

**6way**

Color 色相 Natural 自然色

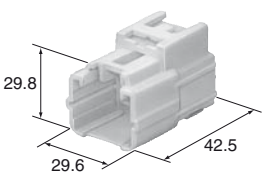

**M (6098-2211)**

**F (6098-1716)**

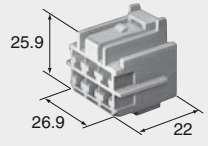

Color 色相 Natural 自然色

**8way**

**F (6098-0518)**

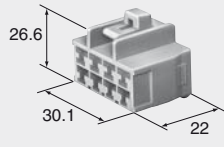

Color 色相 Natural 自然色



**10way**

Color Natural  
色 相 自然色

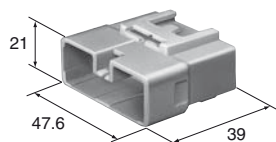

**M (6098-0154)**

**F (6098-0156)**

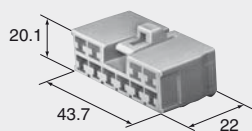

Color Natural  
色 相 自然色

# TS SERIES for STANDARD

8.0mm (312)

A-18

Structure / 構造

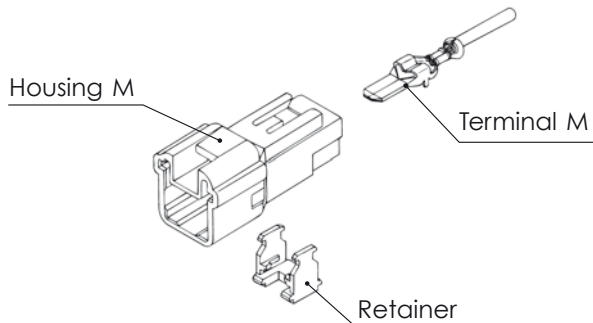

Connector M

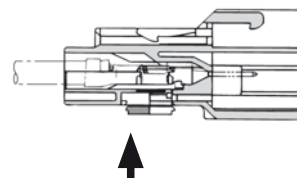

Retainer sliding direction

リテーナを押込むことにより、端子の半挿入状態を検知できます。

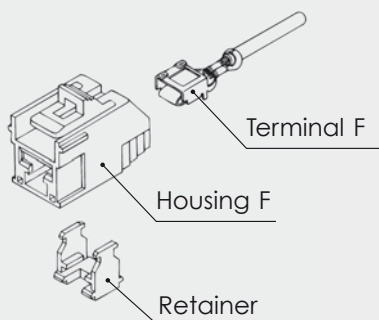

Connector F

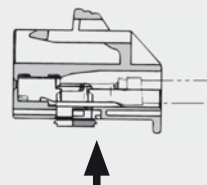

Retainer sliding direction

リテーナを押込むことにより、端子の半挿入状態を検知できます。

8.0mm (312)

Terminal (UNIT : mm)

(S)

Cable size (mm<sup>2</sup>) 適用電線サイズ 0.5~1.25

Material 材質 Brass 黄銅

Surface treatment 表面处理 Tin-plated Snメッキ

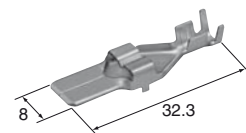

M (8100-0520)

F (8100-0707)

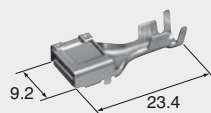

Cable size (mm<sup>2</sup>) 適用電線サイズ 0.5~1.25

Material 材質 Brass 黄銅

Surface treatment 表面处理 Tin-plated Snメッキ

**(M)**

Cable size (mm <sup>2</sup> ) 適用電線サイズ	2.0~3.0
Material 材質	Brass 黄銅
Surface treatment 表面処理	Tin-plated Snメッキ

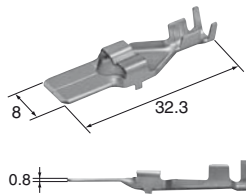
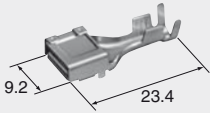
**M (8100-0521)**

Cable size (mm <sup>2</sup> ) 適用電線サイズ	2.0~3.0
Material 材質	Heat-resistant copper alloy
Surface treatment 表面処理	Tin-plated Snメッキ

**F (8100-2493)****(L)**

Cable size (mm <sup>2</sup> ) 適用電線サイズ	5.0~8.0
Material 材質	Brass 黄銅
Surface treatment 表面処理	Tin-plated Snメッキ

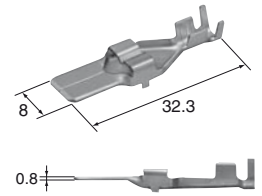
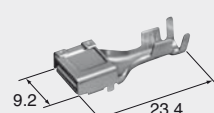
**M (8100-0522)**

Cable size (mm <sup>2</sup> ) 適用電線サイズ	5.0~8.0
Material 材質	Heat-resistant copper alloy
Surface treatment 表面処理	Tin-plated Snメッキ

**F (8100-1553)****8.0mm (312)****Housing** (UNIT : mm)

Ref: Terminal part No.  
ターミナル参照頁

A-18

Material  
材質

PBT

**1way**

Color  
色 相

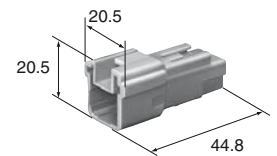
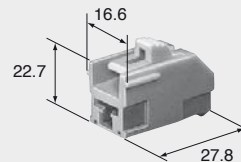
Natural  
自然色**M (6240-1093)****F (6098-0441)**

Color  
色 相

Natural  
自然色**2way**

Color  
色 相

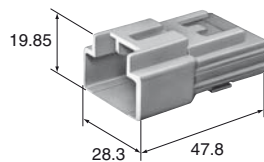
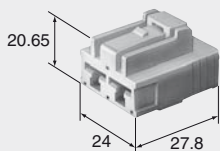
Natural  
自然色**M (6098-1278)**

Color  
色 相

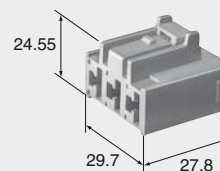
Natural  
自然色**F (6098-1104)****3way****F (6520-1466)**

Color  
色 相

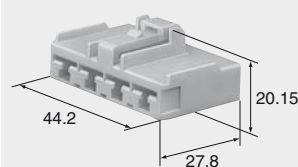
Natural  
自然色**4way****F (6098-2137)**

Color  
色 相

Natural  
自然色

0.64mm, 1.5mm  
(025, 060)

Housing (UNIT : mm)

Ref: Terminal part No. [0.64mm] A-02  
ターミナル参照頁 [1.5mm] A-08

Material PBT  
材質

No. of way/ ( ) corresponds to 0.64mm, 1.5mm, in order from left to right.  
極数 / ( ) 内表示 : 左から 0.64mm 極数、1.5mm 極数

TS SERIES  
for HYBRID

12way (4+8)

Color Natural  
色相 自然色

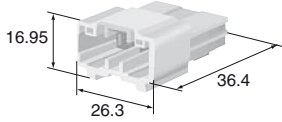

M (6098-6055)

F (6098-6083)

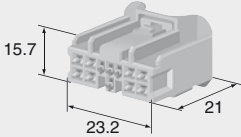

Color Natural  
色相 自然色

12way (6+6)

Color Natural  
色相 自然色

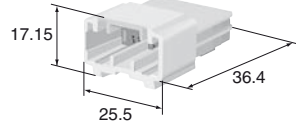

M (6098-6104)

F (6098-6111)

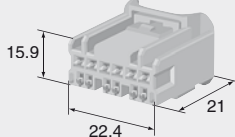

Color Natural  
色相 自然色

12way (8+4)

Color Natural  
色相 自然色

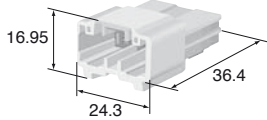

M (6098-6090)

F (6098-6097)

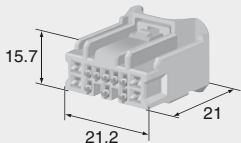

Color Natural  
色相 自然色

18way (8+10)

Color Natural  
色相 自然色

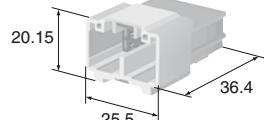

M (6098-5650)

F (6098-5659)

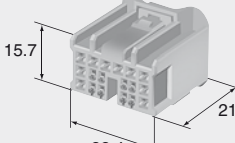

Color Natural  
色相 自然色

**18way (10+8)**

Color: Natural  
色相: 自然色

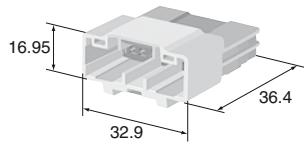

**M (6098-5594)**

**F (6098-5604)**

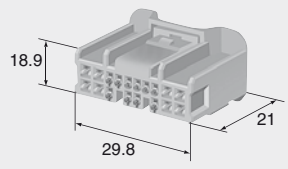

Color: Natural  
色相: 自然色

**18way (12+6)**

Color: Natural  
色相: 自然色

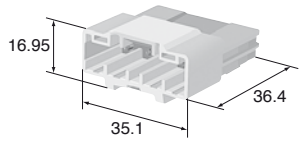

**M (6098-5631)**

**F (6098-5641)**

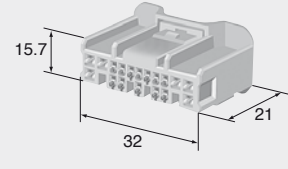

Color: Natural  
色相: 自然色

**20way (16+4)**

Color: Natural  
色相: 自然色

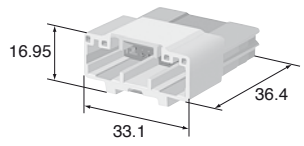

**M (6098-5613)**

**F (6098-5622)**

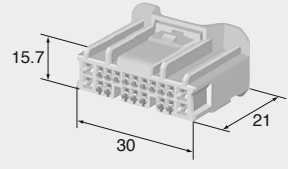

Color: Natural  
色相: 自然色

**0.64mm, 2.3mm (025, 090)**

**Housing (UNIT: mm)**

Ref: Terminal part No. ターミナル参照頁	[0.64mm] A-02 [2.3mm] A-10
Material 材質	PBT

No. of way/ ( ) corresponds to 0.64mm, 2.3mm, in order from left to right.  
極数 / ( ) 内表示: 左から 0.64mm 極数、2.3mm 極数

**17way (8+9)**

Color: Natural  
色相: 自然色

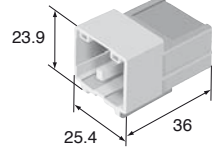

**M (6098-3893)**

**F (6098-3933)**

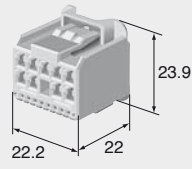

Color: Natural  
色相: 自然色

**18way (10+8)**

Color 色相	Natural 自然色
-------------	----------------

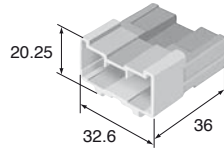
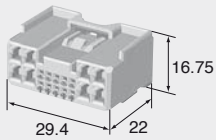
**M (6098-3901)****F (6098-3941)**

Color 色相	Natural 自然色
-------------	----------------

**20way (16+4)**

Color 色相	Natural 自然色
-------------	----------------

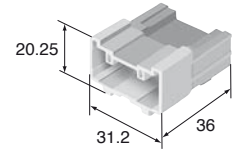
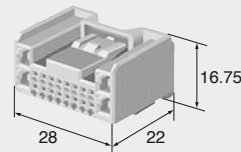
**M (6098-3818)****F (6098-3826)**

Color 色相	Natural 自然色
-------------	----------------

**0.64mm, 4.8mm  
(025, 187)****Housing (UNIT : mm)**

Ref: Terminal part No. ターミナル参照頁	[0.64mm] A-02 [4.8mm] A-14
------------------------------------	-------------------------------

Material 材質	PBT
----------------	-----

No. of way/ ( ) corresponds to 0.64mm, 4.8mm, in order from left to right.  
極数 / ( ) 内表示 : 左から 0.64mm 極数、4.8mm 極数

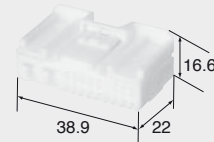
**20way (18+2)****F (6098-5903)**

Color 色相	Natural 自然色
-------------	----------------

**2.3mm, 4.8mm  
(090, 187)****Housing (UNIT : mm)**

Ref: Terminal part No. ターミナル参照頁	[2.3mm] A-10 [4.8mm] A-14
------------------------------------	------------------------------

Material 材質	PBT
----------------	-----

No. of way/ ( ) corresponds to 2.3mm, 4.8mm, in order from left to right.  
極数 / ( ) 内表示 : 左から 2.3mm 極数、4.8mm 極数

**14way (12+2)**

Color 色相	Natural 自然色
-------------	----------------

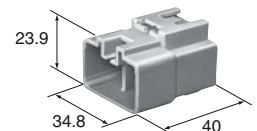
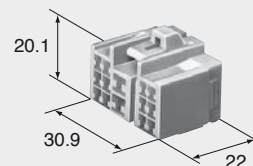
**M (6241-0261)****F (6245-0281)**

Color 色相	Natural 自然色
-------------	----------------

**15way (12+3)**

Color Natural  
色 相 自然色

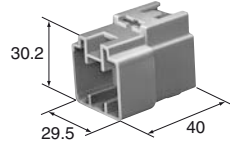

**M (6241-0241)**

**F (6245-0261)**

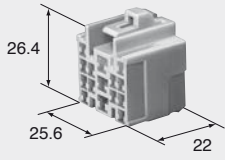

Color Natural  
色 相 自然色

**20way (18+2)**

Color Natural  
色 相 自然色

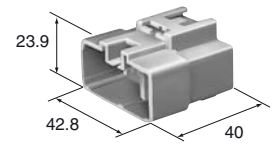

**M (6241-0281)**

**F (6245-0301)**

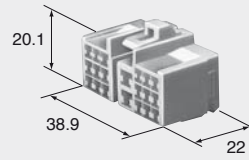

Color Natural  
色 相 自然色

0.64mm (025)

# TS SERIES for PCB

## Housing (UNIT : mm)

### 16way

#### M (6098-6790)

Connector F part No. Fコネクタ品番	6098-4008(A-05)
Material 材質	PBT
Color 色相	Natural 自然色

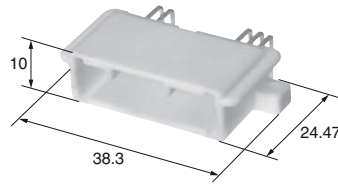

●Detailed dimension  
寸法詳細

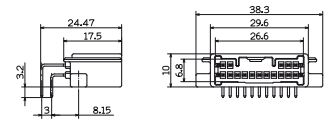

●Recommended dimension of Circuit board  
基板推奨詳細

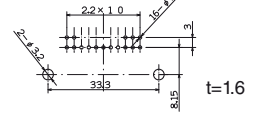

### 16way

#### M (6098-6793)

Connector F part No. Fコネクタ品番	6098-4008(A-05)
Material 材質	SPS
Color 色相	Natural 自然色

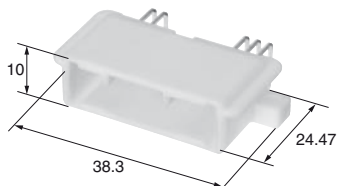

●Detailed dimension  
寸法詳細

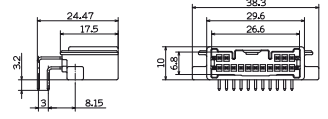

●Recommended dimension of Circuit board  
基板推奨詳細

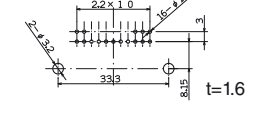

### 36way

#### M (6098-6796)

Connector F part No. Fコネクタ品番	6098-4740(A-06)
Material 材質	PBT
Color 色相	Natural 自然色

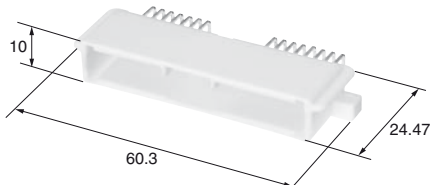

●Detailed dimension  
寸法詳細

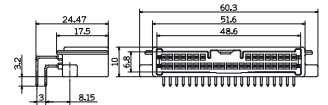

●Recommended dimension of Circuit board  
基板推奨詳細

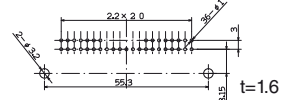



36way

M (6098-6798)

Connector F part No. Fコネクタ品番	6098-4740 (A-06)
Material 材質	SPS
Color 色相	Natural 自然色

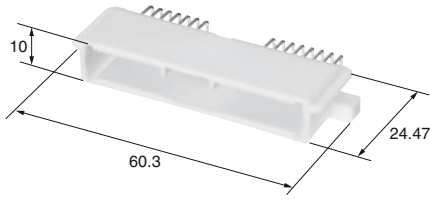

●Detailed dimension  
寸法詳細

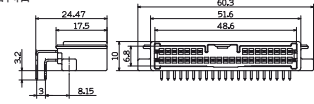

●Recommended dimension of Circuit board  
基板推奨詳細

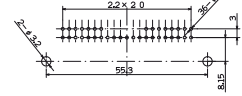

t=1.6

56way (16+16+24)

M (6098-6848)

Connector F part No. Fコネクタ品番	6098-6688 (A-05) 6098-6694 (A-05) 6098-6682 (A-05)
Material 材質	SPS
Color 色相	Natural 自然色

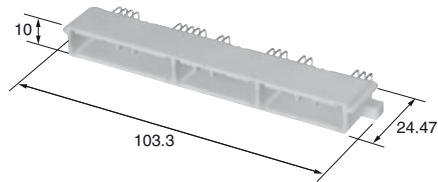

●Detailed dimension  
寸法詳細

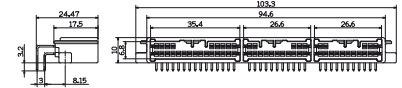

●Recommended dimension of Circuit board  
基板推奨詳細

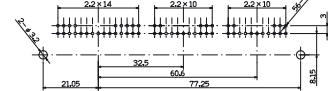

t=1.6

60way (36+24)

M (6098-6802)

Connector F part No. Fコネクタ品番	6098-4010 (A-05) 6098-4740 (A-06)
Material 材質	SPS
Color 色相	Natural 自然色

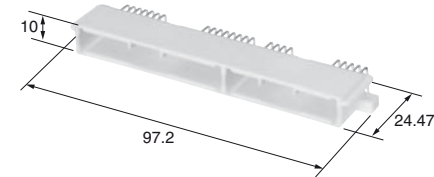

●Detailed dimension  
寸法詳細

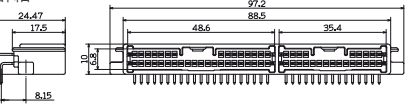

●Recommended dimension of Circuit board  
基板推奨詳細

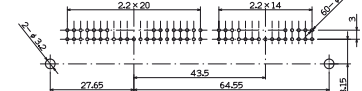

t=1.6

68way (40+28)

M (6098-6805)

Connector F part No. Fコネクタ品番	6098-4756 (A-05) 6098-4831 (A-06)
Material 材質	PBT
Color 色相	Natural 自然色

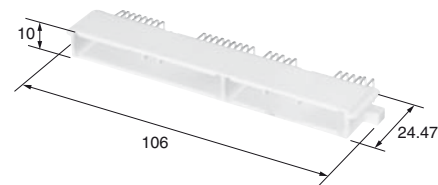

●Detailed dimension  
寸法詳細

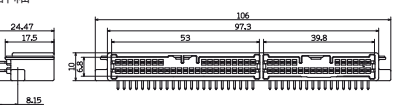

●Recommended dimension of Circuit board  
基板推奨詳細

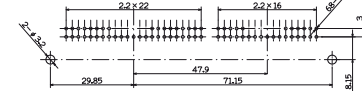

t=1.6

68way (40+28)

M (6098-6807)

Connector F part No. Fコネクタ品番	6098-4756 (A-05) 6098-4831 (A-06)
Material 材質	SPS
Color 色相	Natural 自然色

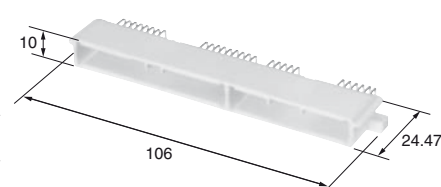

●Detailed dimension  
寸法詳細

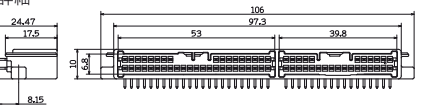

●Recommended dimension of Circuit board  
基板推奨詳細

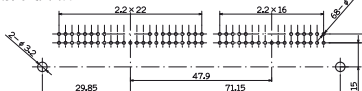

t=1.6

68way (40+28)

M (6098-6809)

A-26

Connector F part No.	6098-4756 (A-05)
Fコネクタ品番	6098-4015 (A-06)
Material	PBT
材質	PBT
Color	Blue
色相	青

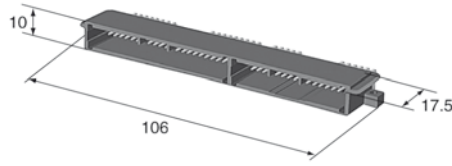

●Detailed dimension  
寸法詳細

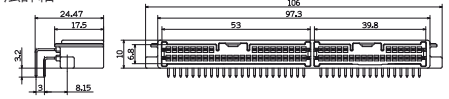

●Recommended dimension of Circuit board  
基板推奨詳細

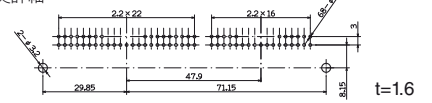

0.64mm, 4.8mm (025, 187)

Housing (UNIT : mm)

No. of way/ ( ) corresponds to 0.64mm, 4.8mm, in order from left to right.  
极数 / ( ) 内显示 : 从左向右0.64mm 极数、4.8mm 极数

20way (18+2)

M (6098-5901)

Connector F part No.	6098-5903 (A-22)
Fコネクタ品番	
Material	PBT
材質	PBT
Color	Natural
色相	自然色

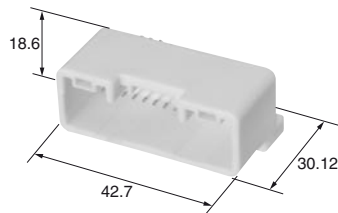

●Detailed dimension  
寸法詳細

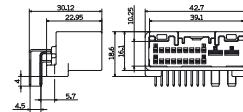

●Recommended dimension of Circuit board  
基板推奨詳細

