



RÜCKSTRAHLER und WARNEINRICHTUNGEN * REFLECTORS and SIGNAL DEVICES

Weitere Rückstrahler finden Sie im Kapitel „LEUCHTEN-SYSTEME“ * For further reflex reflectors please refer to chapter „LIGHTING SYSTEMS“



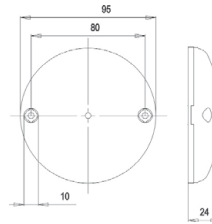

RÜCKSTRAHLER R 710 mit KLARGLASOPTIK * REFLEX REFLECTOR R 710 with CLEAR OPTICS



- für Leuchtenserie 710, 720, 725
- auf 122 mm vergrößerbar mittels einem in verschiedenen Farben lieferbaren Zierring
- 2 Anschraublöcher 6 mm

- for Lights 710, 720, 725
- can be extended by a decoration rim deliverable in different colors to a diameter of 122 mm
- 2 mounting holes 6 mm

Bild Picture	Art.-Nr. / No. Typ / Type	Beschreibung Description	Merkmale Features	Material / Farbe Material / Colour	Anschluss Connection	Gewicht Weight	IP / Temp. IP / Temp.	VP PU	Homolog. Approval
	30.0016.000 R 710 r	Rückstrahler Reflex Reflector	mit Klarglasoptik with clear optics	SAN - PMMA rot - red		0,07 kg		100 E/28	IA E1- 021936

RÜCKSTRAHLER R 110 * REFLEX REFLECTOR R 110





Bild Picture	Art.-Nr. / No. Typ / Type	Beschreibung Description	Merkmale Features	Material / Farbe Material / Colour	Anschluss Connection	Gewicht Weight	IP / Temp. IP / Temp.	VP PU	Homolog. Approval
	30.0015.020 R 110	Rückstrahler Reflex Reflector	2 Anschraublöcher 4,5 mm 2 mounting holes 4.5 mm	PMMA - ABS rot - red		0,12 kg		40 E/16	IA E1- 021606

RÜCKSTRAHLER R 16 * REFLEX REFLECTOR R 16



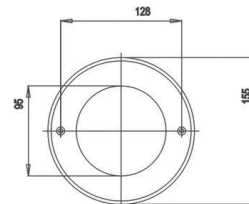

Bild Picture	Art.-Nr. / No. Typ / Type	Beschreibung Description	Merkmale Features	Material / Farbe Material / Colour	Anschluss Connection	Gewicht Weight	IP / Temp. IP / Temp.	VP PU	Homolog. Approval
	30.0001.000 R 16 r	Rückstrahler Reflex Reflector	mit Selbstklebefolie with self-adhesive tape	PMMA - ABS rot - red		0,01 kg		100 E/200	IA E1- 0231306
	30.0001.010 R 16 g	Rückstrahler Reflex Reflector	mit Selbstklebefolie with self-adhesive tape	SAN - ABS gelb - yellow		0,01 kg		100 E/200	IA E1- 0231306
	30.0001.020 R 16 w	Rückstrahler Reflex Reflector	mit Selbstklebefolie with self-adhesive tape	SAN - ABS weiß - white		0,01 kg		100 E/200	IA E1- 0231306

E/xxx Einzelverpackungen auch im Sammelkarton mit xxx Stück erhältlich!
individual packaging available in a collective box with xxx pieces!

RÜCKSTRAHLER und WARNEINRICHTUNGEN * REFLECTORS and SIGNAL DEVICES

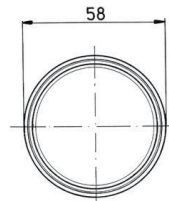
RÜCKSTRAHLER R 17 * REFLEX REFLECTOR R 17



Bild Picture	Art.-Nr. / No. Typ / Type	Beschreibung Description	Merkmale Features	Material / Farbe Material / Colour	Anschluss Connection	Gewicht Weight	IP / Temp. IP / Temp.	VP PU	Homolog. Approval
	30.0002.000 R 17 r	Rückstrahler Reflex Reflector	mit Kunststoff-Fassung und Schraube M5 x 16 with plastic frame and mounting bolt M5 x 16	PMMA - ABS rot - red		0,01 kg		50 E/50	IA E1- 0231306
	30.0002.010 R 17 g	Rückstrahler Reflex Reflector	mit Kunststoff-Fassung und Schraube M5 x 16 with plastic frame and mounting bolt M5 x 16	SAN - ABS gelb - yellow		0,01 kg		50 E/75	IA E1- 0231306
	30.0002.020 R 17 w	Rückstrahler Reflex Reflector	mit Kunststoff-Fassung und Schraube M5 x 16 with plastic frame and mounting bolt M5 x 16	SAN - ABS weiß - white		0,01 kg		50 E/50	IA E1- 0231306

RÜCKSTRAHLER R 86 / R 89 * REFLEX REFLECTOR R 86 / R 89

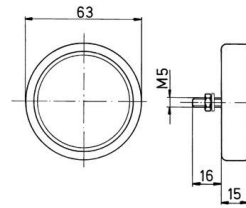

Bild Picture	Art.-Nr. / No. Typ / Type	Beschreibung Description	Merkmale Features	Material / Farbe Material / Colour	Anschluss Connection	Gewicht Weight	IP / Temp. IP / Temp.	VP PU	Homolog. Approval
	30.0003.000 R 86 r	Rückstrahler Reflex Reflector	Anschraubloch 6 mm mounting hole 6 mm	PMMA - ABS rot - red		0,02 kg		100 E/100	IA E1- 0221354
	30.0003.010 R 86 g	Rückstrahler Reflex Reflector	Anschraubloch 6 mm mounting hole 6 mm	SAN - ABS gelb - yellow		0,02 kg		100 E/100	IA E1- 0221354
	30.0003.020 R 86 w	Rückstrahler Reflex Reflector	Anschraubloch 6 mm mounting hole 6 mm	SAN - ABS weiß - white		0,01 kg		100 E/100	IA E1- 0221354
	30.0006.000 R 89 r	Rückstrahler Reflex Reflector	mit Selbstklebefolie self-adhesive tape	PMMA - ABS rot - red		0,02 kg		100 E/100	IA E1- 0221354
	30.0006.010 R 89 g	Rückstrahler Reflex Reflector	mit Selbstklebefolie self-adhesive tape	SAN - ABS gelb - yellow		0,02 kg		100 E/100	IA E1- 0221354
	30.0006.020 R 86 w	Rückstrahler Reflex Reflector	mit Selbstklebefolie self-adhesive tape	SAN - ABS weiß - white		0,01 kg		100 E/100	IA E1- 0221354

RÜCKSTRAHLER R 61 * REFLEX REFLECTOR R 61

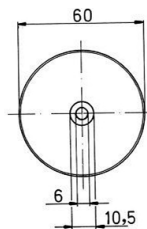

Bild Picture	Art.-Nr. / No. Typ / Type	Beschreibung Description	Merkmale Features	Material / Farbe Material / Colour	Anschluss Connection	Gewicht Weight	IP / Temp. IP / Temp.	VP PU	Homolog. Approval
	30.0009.000 R 61 r	Rückstrahler Reflex Reflector	mit Kunststoff-Fassung with plastic frame	PMMA - ABS rot - red		0,03 kg		25 E/18	IA E1- 31281

RÜCKSTRAHLER und WARNEINRICHTUNGEN * REFLECTORS and SIGNAL DEVICES

RÜCKSTRAHLER R 62 * REFLEX REFLECTOR R 62

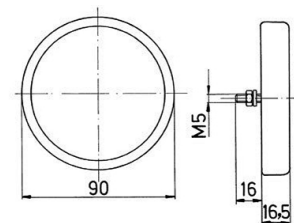

Bild Picture	Art.-Nr. / No. Typ / Type	Beschreibung Description	Merkmale Features	Material / Farbe Material / Colour	Anschluss Connection	Gewicht Weight	IP / Temp. IP / Temp.	VP PU	Homolog. Approval
	30.0010.000 R 62 r	Rückstrahler Reflex Reflector	mit Selbstklebefolie self-adhesive tape	PMMA - ABS rot - red		0,03 kg		50 E/72	IA E1- 31281
	30.0010.010 R 62 g	Rückstrahler Reflex Reflector	mit Selbstklebefolie self-adhesive tape	SAN - ABS gelb - yellow		0,03 kg		50 E/72	IA E1- 31281
	30.0010.020 R 62 w	Rückstrahler Reflex Reflector	mit Selbstklebefolie self-adhesive tape	SAN - ABS weiß - white		0,03 kg		50 E/72	IA E1- 31281

RÜCKSTRAHLER R 65 * REFLEX REFLECTOR R 65

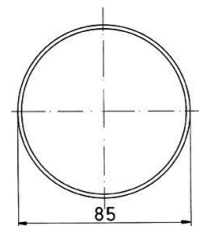
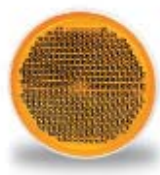

Bild Picture	Art.-Nr. / No. Typ / Type	Beschreibung Description	Merkmale Features	Material / Farbe Material / Colour	Anschluss Connection	Gewicht Weight	IP / Temp. IP / Temp.	VP PU	Homolog. Approval
	30.0011.000 R 65 r	Rückstrahler Reflex Reflector	Anschraubloch 5,5 mm mounting hole 5,5 mm	PMMA - ABS rot - red		0,03 kg		50 E/72	E1-0221362
	30.0011.010 R 65 g	Rückstrahler Reflex Reflector	Anschraubloch 5,5 mm mounting hole 5,5 mm	SAN - ABS gelb - yellow		0,03 kg		50 E/72	E1-0221362
	30.0011.020 R 65 w	Rückstrahler Reflex Reflector	Anschraubloch 5,5 mm mounting hole 5,5 mm	SAN - ABS weiß - white		0,03 kg		50 E/72	E1-0221362

Zubehör / Ersatzteile * Accessories / Spare parts

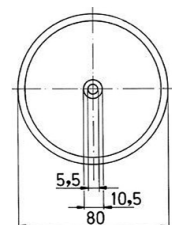
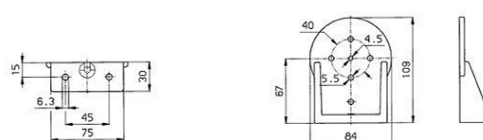

	19.2011.001 WHL 272	Halter Holder	30.0011...	TPU schwarz - black		0,08 kg		50 E/30	
--	-------------------------------	------------------	------------	------------------------	--	---------	--	------------	--

RÜCKSTRAHLER und WARNEINRICHTUNGEN * REFLECTORS and SIGNAL DEVICES

RÜCKSTRAHLER R 115 / R 117 * REFLEX REFLECTOR R 115 / R 117



Bild Picture	Art.-Nr. / No. Typ / Type	Beschreibung Description	Merkmale Features	Material / Farbe Material / Colour	Anschluss Connection	Gewicht Weight	IP / Temp. IP / Temp.	VP PU	Homolog. Approval
	31.0002.000 R 115 r	Rückstrahler Reflex Reflector	2 Anschraublöcher 4,5 mm 2 mounting holes 4.5 mm	PMMA - ABS rot - red		0,03 kg		100 E/100	IA E1- 0121345 *
* = für neue Fahrzeug-Homologationen nicht einsetzbar / cannot be used for new vehicle approvals									
	31.0002.010 R 115 g	Rückstrahler Reflex Reflector	2 Anschraublöcher 4,5 mm 2 mounting holes 4.5 mm	SAN - ABS gelb - yellow		0,03 kg		100 E/100	IA E1- 0121345 *
* = für neue Fahrzeug-Homologationen nicht einsetzbar / cannot be used for new vehicle approvals									
	31.0002.020 R 115 w	Rückstrahler Reflex Reflector	2 Anschraublöcher 4,5 mm 2 mounting holes 4.5 mm	SAN - ABS weiß - white		0,03 kg		100 E/100	IA E1- 0121345 *
* = für neue Fahrzeug-Homologationen nicht einsetzbar / cannot be used for new vehicle approvals									
	31.0004.000 R 117 r	Rückstrahler Reflex Reflector	mit Selbstklebefolie self-adhesive tape	PMMA - ABS rot - red		0,03 kg		100 E/100	IA E1- 0121345 *
* = für neue Fahrzeug-Homologationen nicht einsetzbar / cannot be used for new vehicle approvals									
	31.0004.010 R 117 g	Rückstrahler Reflex Reflector	mit Selbstklebefolie self-adhesive tape	SAN - ABS gelb - yellow		0,03 kg		100 E/100	IA E1- 0121345 *
* = für neue Fahrzeug-Homologationen nicht einsetzbar / cannot be used for new vehicle approvals									
	31.0004.020 R 117 w	Rückstrahler Reflex Reflector	mit Selbstklebefolie self-adhesive tape	SAN - ABS weiß - white		0,03 kg		100 E/100	IA E1- 0121345 *
* = für neue Fahrzeug-Homologationen nicht einsetzbar / cannot be used for new vehicle approvals									

RÜCKSTRAHLER R 118 * REFLEX REFLECTOR R 118

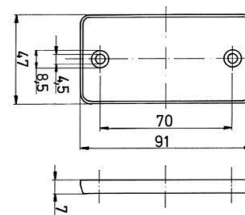

Bild Picture	Art.-Nr. / No. Typ / Type	Beschreibung Description	Merkmale Features	Material / Farbe Material / Colour	Anschluss Connection	Gewicht Weight	IP / Temp. IP / Temp.	VP PU	Homolog. Approval
	31.0005.501 R 118 r	Rückstrahler Reflex Reflector	mit Selbstklebefolie self-adhesive tape	PMMA - ABS rot - red		0,02 kg		100 E/100	IA E9 024006
	31.0005.511 R 118 g	Rückstrahler Reflex Reflector	mit Selbstklebefolie self-adhesive tape	SAN - ABS gelb - yellow		0,02 kg		100 E/100	IA E9 024006
	31.0005.521 R 118 w	Rückstrahler Reflex Reflector	mit Selbstklebefolie self-adhesive tape	SAN - ABS weiß - white		0,02 kg		100 E/100	IA E9 024006

RÜCKSTRAHLER R 150 * REFLEX REFLECTOR R 150

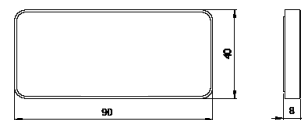

Bild Picture	Art.-Nr. / No. Typ / Type	Beschreibung Description	Merkmale Features	Material / Farbe Material / Colour	Anschluss Connection	Gewicht Weight	IP / Temp. IP / Temp.	VP PU	Homolog. Approval
	31.0009.000 R 150 r	Rückstrahler Reflex Reflector	2 Anschraublöcher 5,4 mm 2 mounting holes 5.4 mm	PMMA - ABS rot - red		0,04 kg		50 E/50	E1-0131313*
* = für neue Fahrzeug-Homologationen nicht einsetzbar / cannot be used for new vehicle approvals									

RÜCKSTRAHLER und WARNEINRICHTUNGEN * REFLECTORS and SIGNAL DEVICES



RÜCKSTRAHLER R 170 * REFLEX REFLECTOR R 170

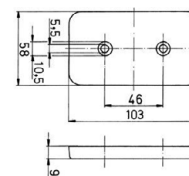

Bild Picture	Art.-Nr. / No. Typ / Type	Beschreibung Description	Merkmale Features	Material / Farbe Material / Colour	Anschluss Connection	Gewicht Weight	IP / Temp. IP / Temp.	VP PU	Homolog. Approval
	31.0015.000 R 170 r	Rückstrahler Reflex Reflector	mit Selbstklebefolie self-adhesive tape	PMMA - ABS rot - red		0,04 kg		100 E/300	E3-0251007
	31.0015.010 R 170 g	Rückstrahler Reflex Reflector	mit Selbstklebefolie self-adhesive tape	SAN - ABS gelb - yellow		0,04 kg		100 E/300	E3-0251007
	31.0015.020 R 170 w	Rückstrahler Reflex Reflector	mit Selbstklebefolie self-adhesive tape	SAN - ABS weiß - white		0,04 kg		100 E/300	E3-0251007

DREIECK - RÜCKSTRAHLER DR 120 * TRIANGULAR REFLEX REFLECTOR DR 120

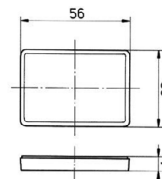
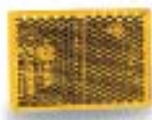
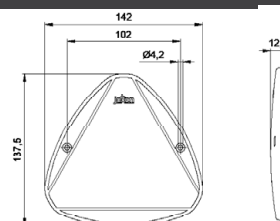

- einteilig
- ovale Form

- one optical element
- oval design

Bild Picture	Art.-Nr. / No. Typ / Type	Beschreibung Description	Merkmale Features	Material / Farbe Material / Colour	Anschluss Connection	Gewicht Weight	IP / Temp. IP / Temp.	VP PU	Homolog. Approval
	32.0005.020 DR 120	Dreieck - Rückstrahler Triangular Reflex Reflector		PMMA - ABS rot - red		0,09 kg		100 E/18	E1-023054

DREIECK - RÜCKSTRAHLER DR 110 * TRIANGULAR REFLEX REFLECTOR DR 110

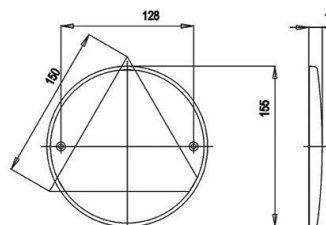

- einteilig
- runde Form

- one optical element
- round design

Bild Picture	Art.-Nr. / No. Typ / Type	Beschreibung Description	Merkmale Features	Material / Farbe Material / Colour	Anschluss Connection	Gewicht Weight	IP / Temp. IP / Temp.	VP PU	Homolog. Approval
	32.0001.020 DR 110	Dreieck - Rückstrahler Triangular Reflex Reflector		PMMA - ABS rot - red		0,10 kg		100 E/5	E1-021352

RÜCKSTRAHLER und WARNEINRICHTUNGEN * REFLECTORS and SIGNAL DEVICES



DREIECK - RÜCKSTRAHLER DR 106-2 * TRIANGULAR REFLEX REFLECTOR DR 106-2

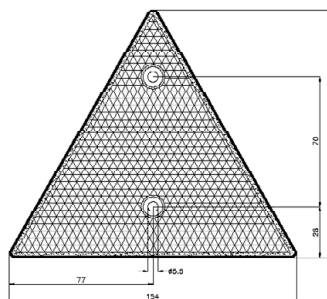

	· einteilig · 2 x M 5 x 5,2 mm			· one optical element · 2 x M 5 x 5,2 mm						
Bild Picture	Art.-Nr. / No. Typ / Type	Beschreibung Description	Merkmale Features	Material / Farbe Material / Colour	Anschluss Connection	Gewicht Weight	IP / Temp. IP / Temp.	VP PU	Homolog. Approval	
	32.0004.200 DR 106 - 3b	Dreieck - Rückstrahler Triangular Reflex Reflector	schwarzer Kunststoff -Boden black plastic base	PMMA - ABS rot, schwarz - red, black		0,07 kg		100	E3-51005	E/50

DREIECK - RÜCKSTRAHLER DR 107 * TRIANGULAR REFLEX REFLECTOR DR 107



Bild Picture	Art.-Nr. / No. Typ / Type	Beschreibung Description	Merkmale Features	Material / Farbe Material / Colour	Anschluss Connection	Gewicht Weight	IP / Temp. IP / Temp.	VP PU	Homolog. Approval	
	32.0006.000 DR 107	Dreieck - Rückstrahler Triangular Reflex Reflector	mit Selbstklebefolie self-adhesive tape	PMMA - ABS rot, schwarz - red, black		0,07 kg		32	E13-35126	
	32.0006.200 DR 107/A	Dreieck - Rückstrahler Triangular Reflex Reflector	mit Selbstklebefolie / Arretierzapfen self-adhesive tape / lock in place pins	PMMA - ABS rot, schwarz - red, black		0,07 kg		32	E13-35126	

RÜCKSTRAHLER und WARNEINRICHTUNGEN * REFLECTORS and SIGNAL DEVICES



WARNTAFELN * SIGNAL PANELS

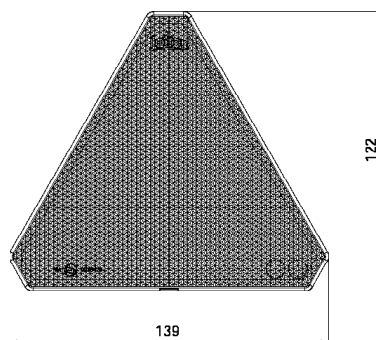

Bild Picture	Art.-Nr. / No. Typ / Type	Beschreibung Description	Merkmale Features	Material / Farbe Material / Colour	Anschluss Connection	Gewicht Weight	IP / Temp. IP / Temp.	VP PU	Homolog. Approval
	36.0010.000	Sonderlasten - Warntafel Warning Panel	für Italien, 500 x 500 mm for Italy, 500 x 500 mm	Aluminium- aluminum rot, weiß - red, white		0,84 kg		10	
		Zusatz-Information: Additional Information:	erforderlich bei überstehender Ladung / mit reflektierender Folie required for protruding load / with reflective adhesive film						
	36.0011.000	Sonderlasten - Warntafel Warning Panel	für Spanien, 500 x 500 mm for Spain 500 x 500 mm	Aluminium- aluminum rot, weiß - red, white		0,84 kg		10	
		Zusatz-Information: Additional Information:	erforderlich bei überstehender Ladung / mit reflektierender Folie required for protruding load / with reflective adhesive film						

WARNSCHILD * WARNING PANEL



<ul style="list-style-type: none"> · für langsam fahrende Fahrzeuge und Anhänger · entsprechend ECE-REG. 69 · Innenteil mit fluoreszierender Leuchtfolie · Außenteil mit drei mit der Bodenplatte verschweißten Rückstrahlerleisten aus Kunststoff · mit oder ohne Befestigungsteilen 		<ul style="list-style-type: none"> · for slow vehicles and trailers · acc. to ECE 69 · interior surface with fluorescent film · outer part made of three reflex reflector plastic parts bonded to the base plate · with or without fastening elements 									
Bild Picture	Art.-Nr. / No. Typ / Type	Beschreibung Description	Merkmale Features	Spann. Voltage	Leistung Power	Material / Farbe Material / Colour	Anschluss Connection	Gewicht Weight	IP / Temp. IP / Temp.	VP PU	Homolog. Approval
	36.0006.000	Warnschild Warning panel	m. Befestigungsteilen w. fastening elements			PVC rot - red		0,76 kg		10	E20-010001 E/24
	36.0006.100	Warnschild Warning panel	m. Befestigungsteilen w/o fastening elements			PVC rot - red		0,76 kg		10	E20-010001 E/24

LEITUNGEN UND STECKVERBINDUNGEN PLUGS AND SOCKETS

Setzt unter Spannung: alles was Sie rund um den Anschluß und die Energieversorgung von Leuchten benötigen, finden Sie bei JOKON. Als Experte für kundenspezifische Lösungen sorgen wir dafür, dass auch besonders anspruchsvolle Leuchten-Kombinationen sicher und zuverlässig funktionieren.

Get live: you will find everything you need relating to connection and energy supply of lights at JOKON. As experts in customised solutions, we ensure that even particularly sophisticated light combinations operate safely and reliably.

