

# HD10 Series

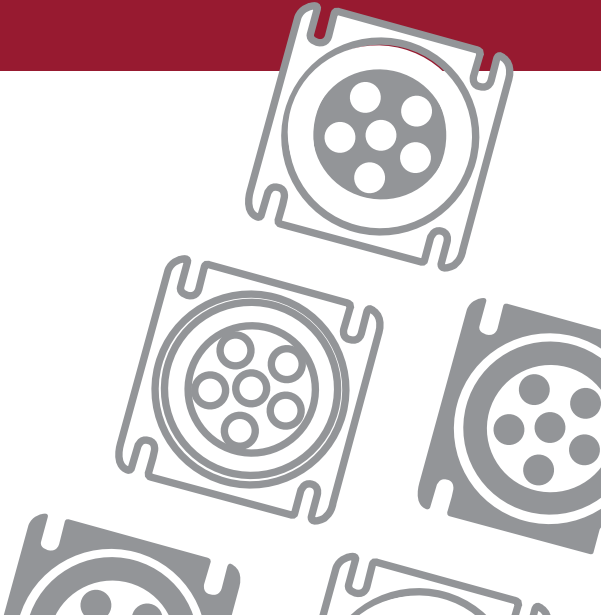

## Contents

HD10 Series Overview	62
Part Numbering System	62
Dimensions	62
Connector Styles	63
Configurations	63
Special Modifications	63-64
Accessories	64-67



# HD10 Series

## HD10 Series Overview

The HD10 Series is an environmentally sealed, thermoplastic cylindrical connector series and offers arrangements from 3 to 9 cavities. All HD10 connectors are available either in-line or flanged and accept size 12 or 16 contacts, or a combination of size 16 and size 4 contacts. The HD10 Series is heavily used for diagnostic connectors, helps reduce assembly issues and maintenance time, and is designed for long service life.



### Part Numbering System

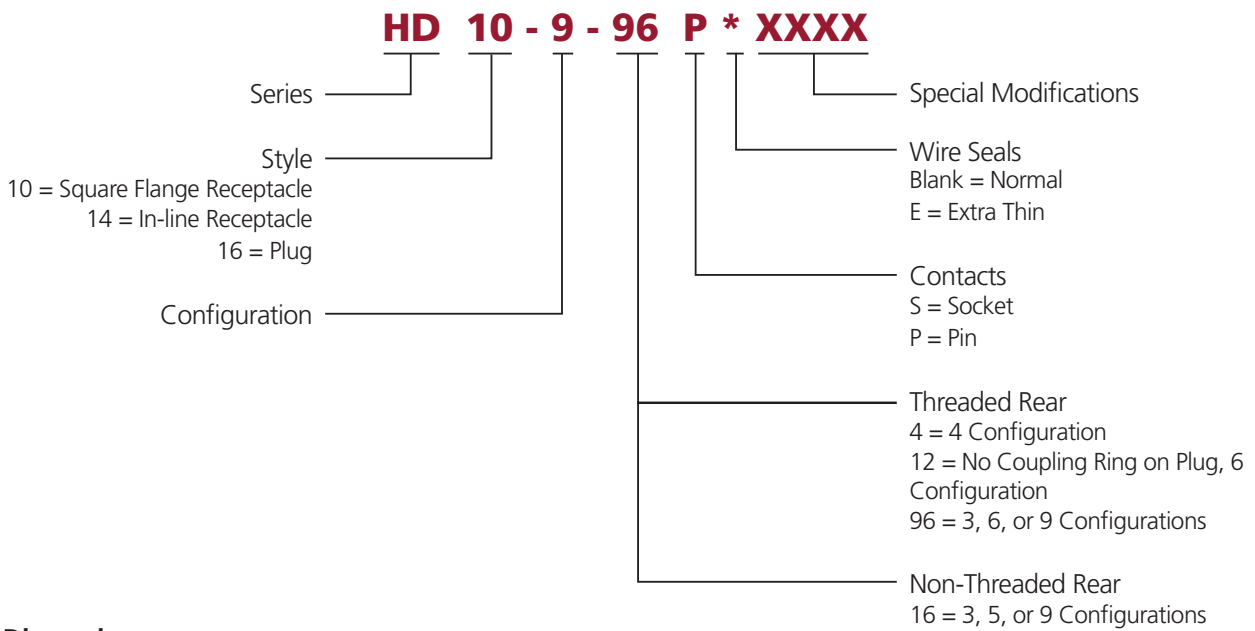

### Dimensions

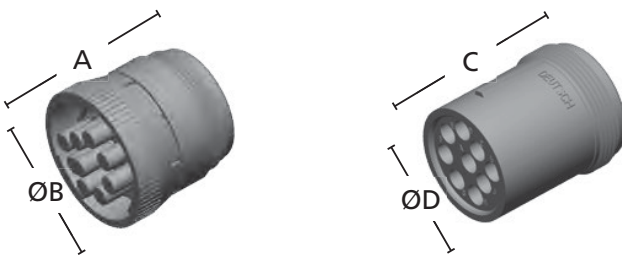

Cavity	HD10 Plug		HD10 Receptacle	
	Overall Length A	Overall Height ØB	Overall Length C	Overall Height ØD
3	1.609 (40.87)	1.069 (27.15)	1.639 (41.63)	.851 (21.62)
4	1.639 (41.63)	1.595 (40.51)	1.639 (41.63)	1.281 (32.54)
5	1.609 (40.87)	1.218 (30.94)	1.639 (41.63)	1.001 (25.43)
6	1.619 (41.12)	1.453 (36.91)	1.639 (41.63)	1.141 (28.98)
9	1.609 (40.87)	1.593 (40.47)	1.639 (41.63)	1.281 (32.54)

Dimensions are for reference only.



## ■ Connector Styles

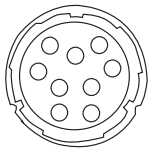

Plug HD16

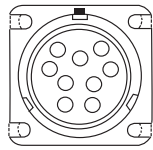

Square Flange Receptacle HD10

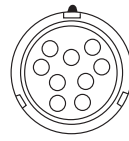

In-line Receptacle HD14

## ■ Configurations

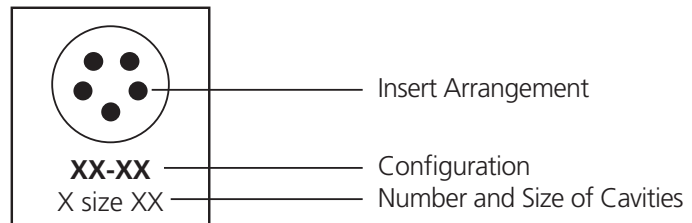

**3-16/3-96\***  
3 size 16



**4-4**  
1 size 4  
3 size 16



**5-16**  
5 size 16



**6-12**  
6 size 12



**6-96**  
6 size 16

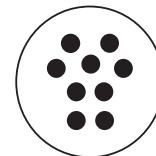

**9-16**  
9 size 16

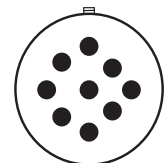

**9-96\***  
9 size 16

\*Also available in an "E" seal

## Special Modifications

The HD10 Series connectors offer several modifications to enhance the design flexibility and meet application specific needs. Options include the addition of a coupling ring and connector body color, just to mention a few. By combining the HD10 Series connectors with the available modifications and accessories, the design possibilities are increased.

### ■ B010 Modification

The B010 modification provides the addition of a coupling ring used for mating. The B010 modification is only available on the HD16-6-12S-B010 connector.



### ■ E004 Modification

The E004 modification changes the HD10 Series connector from the standard gray to a black connector body.



# HD10 Series

## N005 Modification

The N005 modification is an HD10 Series receptacle with molded-in, straight PCB pins.



## J1939 Modifications (BP03, P080)

The P080 modification changes the HD10 Series connector body color from the standard gray to green and meets the J1939 Type II requirements. The BP03 modification is similar to the P080 modification, but features a panel mount.



### Notice

Please see Contacts section for extended PCB pins.

## Accessories

Several accessory items are available to complement the HD10 Series connectors including boots, backshells, gaskets, and protective caps. Accessory items cover a wide array of design requirements such as assisting with mounting, providing additional protection, and offering enhanced aesthetics.

## Backshells



The DEUTSCH HD10 Series backshells are designed to screw onto all threaded HD10 connectors. Rated for temperatures from -40°C to +134°C, the rigid, durable backshells offer a high level of protection, provide strain relief, and improve aesthetics.

### Backshell and Compression Nut Assembly



Connector Part Number	Cable Diameter	Backshell Part Number	Compression Nut Part Number
<b>DEUTSCH HD10 Series 3 Way</b> HD1*-3-96*	.187-.300	M902-2131	M902-2041
	.300-.430	M902-2132	M902-2042
<b>DEUTSCH HD10 Series 6 Way</b> HD1*-6-96* HD1*-6-12*	.187-.300	M902-2161	M902-2041
	.300-.430	M902-2162	M902-2042
	.430-.570	M902-2163	M902-2053
	.570-.710	M902-2164	M902-2054
<b>DEUTSCH HD10 Series 9 Way</b> HD1*-9-96* HD1*-9-1939**	.187-.300	M902-2191	M902-2041
	.300-.430	M902-2192	M902-2042
	.430-.570	M902-2193	M902-2053
	.570-.710	M902-2194	M902-2054

Backshell Technical Specifications:

Material - PC/PET Polyester Blend, UV-Stabilized, Flame Retardant, Black  
Flammability - UL94-VO, Weatherability - UL746C

## ■ Strain Relief

DEUTSCH HD10 Series strain reliefs are designed to screw onto threaded 3, 4, 6, and 9 cavity HD10 connectors. The rigid, durable strain reliefs offer a high level of protection, provide tie wrap holders to reduce the strain from the wires, and improve aesthetics.



Part Number	Description
HD18-003	3 cavity strain relief
HD18-006	6 cavity strain relief
HD18-009	4 or 9 cavity strain relief



*Attaching the connector to a structure eliminates straining the electrical system in service.*



## ■ Protective Dust Caps

The HD10 Series protective dust caps provide an environmental seal and are used to protect the connector interface when the connector is not mated.



### HDC14 Protective Cap for Plug

Part Number	Description
HDC14-3	3 cavity plug protective cap
HDC14-6	6 cavity plug protective cap
HDC14-9	9 cavity plug protective cap

### HDC16 Protective Cap for Receptacle

Part Number	Description
HDC16-3	3 cavity receptacle protective cap
HDC16-5	5 cavity receptacle protective cap
HDC16-6	6 cavity receptacle protective cap
HDC16-6-E004	6 cavity receptacle protective cap, black
HDC16-9	9 cavity receptacle protective cap
HDC16-9-E004	9 cavity receptacle protective cap, black

# HD10 Series

## Boots



Boots provide a professional looking finishing touch for DEUTSCH HD10 Series connectors. Made of durable plastisol, these slip-on boots are not only aesthetically appealing, but also provide increased protection from dirt, paint overspray, and pressure washing. The plastisol boots are rated from -20° F to +212° F and offer a slip-on design making installation quick and easy.



Part Number	Description
HD10-3BT	3 cavity boot, gray
HD10-5BT	5 cavity boot, gray
HD10-5BT-BK	5 cavity boot, black
HD10-6BT	6 cavity boot, gray
HD10-6BT-BK	6 cavity boot, black
HD10-9BT	9 cavity boot, gray
HD10-9BT-BK	9 cavity boot, black

\*Distorting the boots can lessen their longevity

## Gaskets



Moisture, dirt, salt, sand, and road debris can work their way into electrical panels through unsealed mounting flanges. Rated to operate in environments from -70°F to +225°F, these rugged high quality neoprene gaskets form a tight seal between the panel face and connector flange to help keep out destructive elements. The gaskets have a thickness of .125" and meet the UL-94-HBF, Mil-R-6130C, and FMVSS-302 flammability specifications.



Gasket P/N	Connector P/N
HD10-3-GKT	HD10-3-****
HD10-5-GKT	HD10-5-****
HD10-6-GKT	HD10-6-****
HD10-9-GKT	HD10-9-****

## Lanyards





Lanyards are available in nitrile or nylon coated steel and designed for use with protective dust caps.



HDC9-JDL082397  
(DEUTSCH HDC16-9-E004 dust cap  
assembled with JDL082397)



HDC16-9-L47N  
(DEUTSCH HDC16-9 dust cap  
assembled with L47N-600-1)

Lanyard	Material	Material Diameter	Length	Minimum Breaking Strength
 JDL082397	Nitrile o-ring, 3M heat shrink with thermoplastic adhesive	.07 inches	5.31 inches	---
 L47N-600-1	7 x 7 galvanized steel cable coated with clear nylon	.047 inches	6 inches	270 lbs.

Dimensions are for reference only.

## Dust Cap/Lanyard Assemblies

Part Number*	Used On	Connector Cavities	Lanyard Material	Dust Cap Color
HDC14-3-JDL	Plug	3	Nitrile	Gray
HDC14-6-JDL	Plug	6	Nitrile	Gray
HDC14-6-LA	Plug	6	Steel	Gray
HDC14-9-JDL	Plug	9	Nitrile	Gray
HDC16-3-JDL	Receptacle	3	Nitrile	Gray
HDC16-3-LA	Receptacle	3	Steel	Gray
HDC16-5-LA	Receptacle	5	Steel	Gray
HDC16-6-JDL	Receptacle	6	Nitrile	Gray
HDC16-6-LA	Receptacle	6	Steel	Gray
HDC16-9-JDL	Receptacle	9	Nitrile	Gray
HDC9-JDL082397	Receptacle	9	Nitrile	Black
HDC16-9-L47N	Receptacle	9	Steel	Gray
HDC16-9-E004-L47N	Receptacle	9	Steel	Black

\*Other dust cap/lanyard assemblies may be available

